



CYPRESS MARKING FORMAT

July 2017

▪Note:

▪The diagrams are provided for illustrative purposes only. Please note that the actual marking format may vary depending on package size, type and pin count. Should you have any other concerns and questions, feel free to contact your local CY sales representative. Markings for costumed parts CS/CG, acquired and buy-in parts are not included on this document.

▪The diagrams below is based on the latest Cypress Marking Spec 37-00001 Rev.. JB



LEGEND:

Character	Meaning	Remarks
b	Blank Space	
d	Marketing Part Number	
111	CYP	11 = CY 1111111 = CYPRESS
ff	Fab Location	
rr	Backend Part Revision	
yyww	Date Code	yy = last two digit of the year ww = Workweek
nnnnnn	Mark Lot Number	nnnnnn = First and last five digits of Mark Lot Number nnnn = last four digit of Mark Lot Number
xxx	Country of Origin	xxxx = COO with "." at the end Ex. PHI.
C	Copper Wire Part	

SOIC 8L

Using Gold (Au) Wire

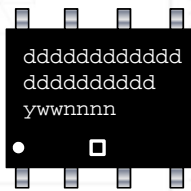

- 1st line (12 characters) is the marketing part number
- 2nd line (10 characters) is the rest of the marketing part number
- 3rd line (7 characters) is the date code and lot code.

Using Copper (Cu) Wire

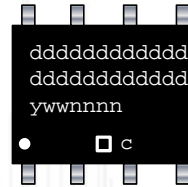

- 1st line (12 characters) is the marketing part number
- 2nd line (10 characters) is the rest of the marketing part number
- 3rd line (7 characters) is the date code and lot code.
- The 'C' beside the square mark (Pb-Free mark) denotes the use of copper wire.

Example Marking Format: CY2305SXI-1H

:Line 1: CY2305S
Line 2: XI-1H
Line 3: 2075794

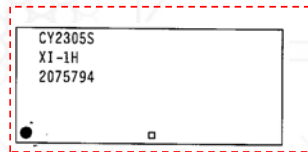

Note:

1. First line to mark the marketing part number before the first S character.
2. 2nd line the rest of the marketing part number.
3. 3rd line ywwnnnn where y= last digit of the year ww= work week nnnn= last four digits of the lot number.
4. If the marketing part number has more than 7 characters before the S than the first 7 characters will print on line 1 with the remaining 7 characters wrapping to line 2.

Packages :

- SOIC 8 - 150 mils

SOIC 14L/SOIC 16L

Using Gold (Au) Wire



1st line (16 characters) is the marketing part number

2nd line (14 characters) is the date code, fab site and backend revision

3rd line is the COO, 'CYP' and lot code.

Using Copper (Cu) Wire



1st line (16 characters) is the marketing part number

2nd line (14 characters) is the date code, fab site and backend revision

3rd line is the COO, 'CYP' and lot code.

The 'C' beside the square mark (Pb-Free mark) denotes the use of copper wire.

Example Marking Format: : CY7C63801-SXC.

Line 1: CY7C63801-SXC
Line 2: 1307 04 A
Line 3: PHI CYP 607050

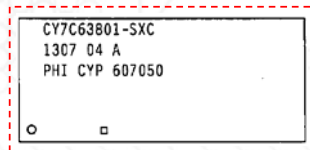

Note:

1. If Mkt. PN on line 2 contains ≤5 char, move yyww to the second line after the Mkt. PN separated with a blank then wrap the rfff to the left
2. If BE Part Rev has only one character, use rbff format instead of rfff
3. For Non-MIA devices, mark last four digits of the assembly lot number (nnnn) beside the pin 1 indicator.

Packages :

- SOIC 14 - 150 mils
- SOIC 16 - 150 mils

SOIC 16L/SOIC 18L

Using Gold (Au) Wire



Lines 1 – 4: 10 characters per line
Line 5: 4 characters

1st and 2nd line is the marketing part number. If Mkt. PN on line 2 contains ≤5 char, move yyww to the second line after the Mkt. PN separated with a blank then wrap the rrrf to the left.

3rd line is the date code, backend revision and fab site. If BE Part Rev has only one character, use rbff format instead of rrrf

4th line is the lot code

Using Copper (Cu) Wire

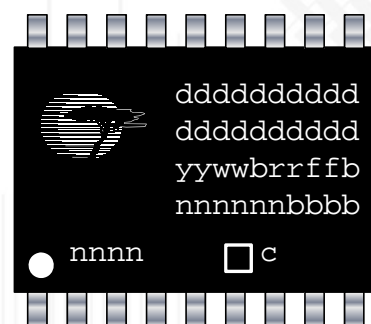

Lines 1 – 4: 10 characters per line
Line 5: 4 characters

1st and 2nd line is the marketing part number. If Mkt. PN on line 2 contains ≤5 char, move yyww to the second line after the Mkt. PN separated with a blank then wrap the rrrf to the left.

3rd line is the date code, backend revision and fab site. If BE Part Rev has only one character, use rbff format instead of rrrf

4th line is the lot code

The 'C' beside the square mark (Pb-Free mark) denotes the use of copper wire.

Example Marking Format: : CY7C63801-SXC.

Line 1: CY7C63813-
Line 2: SXC 1237
Line 3: A 05
Line 4: 631859

Note:

1. For Non-MIA devices, mark last four digits of the assembly lot number (nnnn) beside the pin 1 indicator.

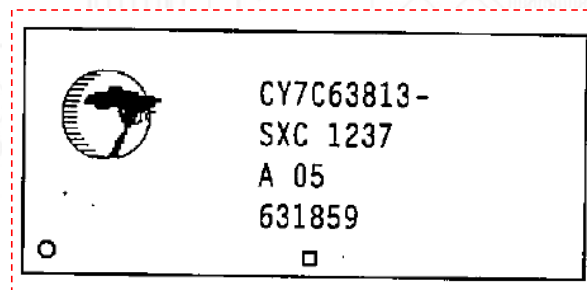

Packages :

- SOIC 16L – 300 mils
- SOIC 16L - 300 mils

SOIC 20L/SOIC 24L

Using Gold (Au) Wire

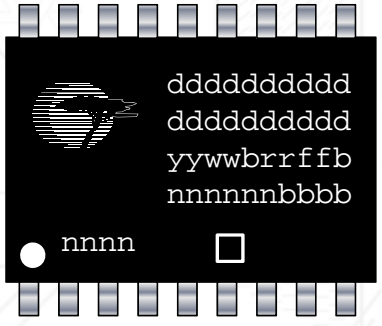

Lines 1 – 4: 10 characters per line
 Line 5: 4 characters

1st and 2nd line is the marketing part number.

3rd line is the date code, backend revision and fab site

4th line is the lot code

Using Copper (Cu) Wire

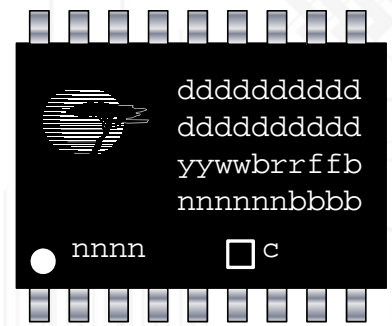

Lines 1 – 4: 10 characters per line
 Line 5: 4 characters

1st and 2nd line is the marketing part number.

3rd line is the date code, backend revision and fab site

4th line is the lot code

The 'C' beside the square mark (Pb-Free mark) denotes the use of copper wire.

Example Marking Format: : CY8C24223A-24SXI

Line 1: CY8C24223
 Line 2: A-24SXI
 Line 3: 1131 C 05
 Line 4: 643236

- Note:
1. If Mkt. PN is >10 char, break the Mkt. PN after the 10th character then move the remaining characters on the second line.
 2. If the dash ("-") falls in any character before the 10th character, break the Mkt. PN after the dash then move the remaining characters to the second line.
 3. If characters "A", "C", or "P" falls in any characters before the 10th character, break the Mkt. PN after "A", "C", or "P" characters then move the remaining characters on the second line.

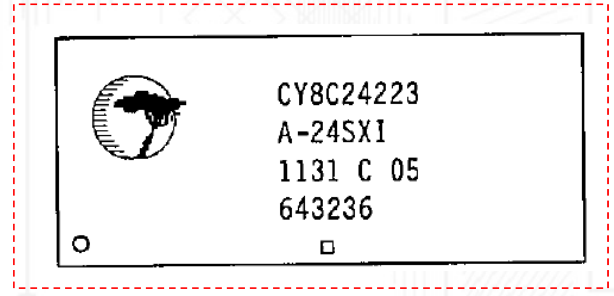

SOIC 28L/SOIC 44L

Using Gold (Au) Wire



Lines 1 – 4: 12 characters per line
Line 5: 4 characters

1st and 2nd line is the marketing part number. If Mkt. PN is ≤12 characters, move line 3 to line 2 then succeeding lines follows.

3rd line is the date code and lot code

4th line is the backend revision and fab site. If BE Part Rev has only one character, then use rbff format instead of rfff.

xxxx – Country of Origin (COO) – for Packages with no engraved COO.

Using Copper (Cu) Wire



Lines 1 – 4: 12 characters per line
Line 5: 4 characters

1st and 2nd line is the marketing part number. If Mkt. PN is ≤12 characters, move line 3 to line 2 then succeeding lines follows.

3rd line is the date code and lot code

4th line is the backend revision and fab site. If BE Part Rev has only one character, then use rbff format instead of rfff.

xxxx – Country of Origin (COO) – for Packages with no engraved COO.

The 'C' beside the square mark (Pb-Free mark) denotes the use of copper wire.

Example Marking Format: : CY7C65113C-SXC

Line 1: CY7C65113C-
Line 2: SXC
Line 3: 1137 647027
Line 4: PHI G 23

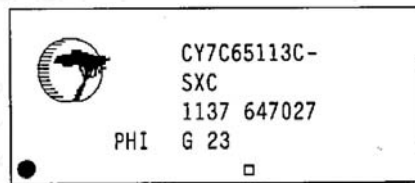

Note:

1. If Mkt. PN is >12 characters, break the Mkt. PN after the 12th character then move the remaining characters to the second line.
2. If the dash ("-") falls in any character before the 12th character, break the Mkt. PN after the dash ("-") then move the remaining character to the second line.
3. For Non-MIA devices, mark last four digits of the assembly lot number (nnnn) beside the pin 1 indicator.

Packages :

- SOIC 28 - 300/400/450 mils
- SOIC 44 - 300/400/450 mils

SOIC 28L/SOIC 44L (SNC – GULL WING)

Using Gold (Au) Wire

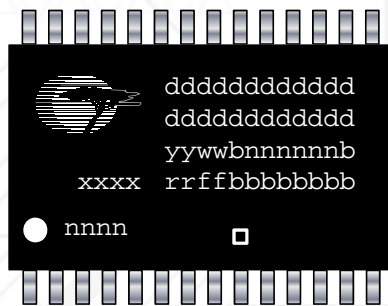

Lines 1 – 4: 12 characters per line
Line 5: 4 characters

1st and 2nd line is the marketing part number. If Mkt. PN is ≤12 characters, move line 3 to line 2 then succeeding lines follows.

3rd line is the date code and lot code

4th line is the backend revision and fab site. If BE Part Rev has only one character, then use rbff format instead of rfff.

xxxx – Country of Origin (COO) – for Packages with no engraved COO.

Using Copper (Cu) Wire



Lines 1 – 4: 12 characters per line
Line 5: 4 characters

1st and 2nd line is the marketing part number. If Mkt. PN is ≤12 characters, move line 3 to line 2 then succeeding lines follows.

3rd line is the date code and lot code

4th line is the backend revision and fab site. If BE Part Rev has only one character, then use rbff format instead of rfff.

xxxx – Country of Origin (COO) – for Packages with no engraved COO.

The 'C' beside the square mark (Pb-Free mark) denotes the use of copper wire.

Example Marking Format: : CY62256EV18LL-70SNXI

Line 1: CY62256EV18L
Line 2: L-70SNXI
Line 3: 1125 635328
Line 4: PHI F 04

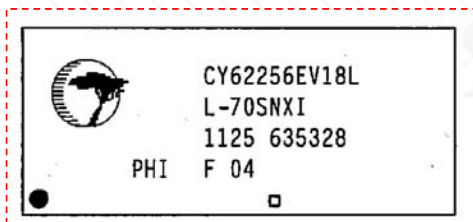

Note:

1. If Mkt. PN is >12 characters, break the Mkt. PN after the 12th character then move the remaining characters to the second line.
2. If the dash ("-") falls in any character before the 12th character, break the Mkt. PN after the dash ("-") then move the remaining character to the second line.
3. For Non-MIA devices, mark last four digits of the assembly lot number (nnnn) beside the pin 1 indicator.

Packages :

- SOIC 28 - 300/400/450 mils
- SOIC 44 - 300/400/450 mils

SOJ 16L/SOJ 18L

Using Gold (Au) Wire



Lines 1 – 4: 10 characters per line
Line 5: 4 characters

1st and 2nd line is the marketing part number.

3rd line is the date code, backend revision and fab site

4th line is the lot code

Using Copper (Cu) Wire



Lines 1 – 4: 10 characters per line
Line 5: 4 characters

1st and 2nd line is the marketing part number.

3rd line is the date code, backend revision and fab site

4th line is the lot code

The 'C' beside the square mark (Pb-Free mark) denotes the use of copper wire.

No Example Available

- Packages :
- SOJ16 - 300 mils
 - SOJ18 - 300 mils

SOJ 20L/SOJ 24L

Using Gold (Au) Wire

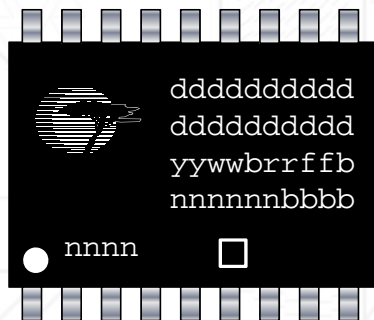

Lines 1 – 4: 10 characters per line
Line 5: 4 characters

1st and 2nd line is the marketing part number.

3rd line is the date code, backend revision and fab site

4th line is the lot code

Using Copper (Cu) Wire

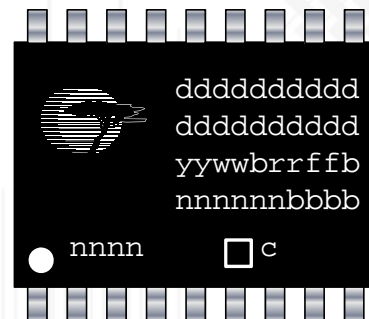

Lines 1 – 4: 10 characters per line
Line 5: 4 characters

1st and 2nd line is the marketing part number.

3rd line is the date code, backend revision and fab site

4th line is the lot code

The 'C' beside the square mark (Pb-Free mark) denotes the use of copper wire.

Example Marking Format: : CY7C128A-20VXC

Line 1: CY7C128A-
Line 2: 20VXC 1131
Line 3: F 02
Line 4: 643588

Note:

1. If Mkt. PN is >10 char, break the Mkt. PN after the 10th character then move the remaining characters on the second line.
2. If the dash ("-") falls in any character before the 10th character, break the Mkt. PN after the dash then move the remaining characters to the second line.
3. If characters "A", "C", or "P" falls in any characters before the 10th character, break the Mkt. PN after "A", "C", or "P" characters then move the remaining characters on the second line.

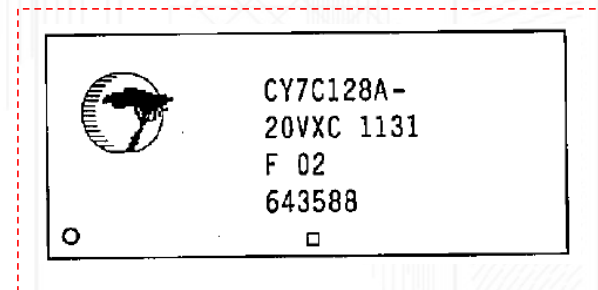

SOJ 28L - SOJ 44L

Using Gold (Au) Wire

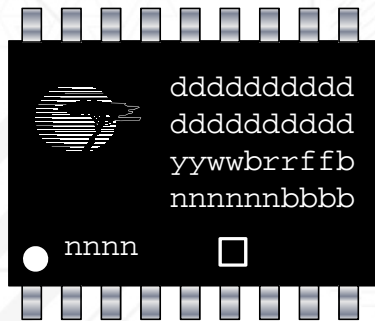

Lines 1 – 4: 12 characters per line
Line 5: 4 characters

1st and 2nd line is the marketing part number. If Mkt. PN on line 2 contains ≤5 char, move yyww to the second line after the Mkt. PN and date code.

3rd line is the backend revision, fab site, and lot code

Using Copper (Cu) Wire



Lines 1 – 4: 12 characters per line
Line 5: 4 characters

1st and 2nd line is the marketing part number. If Mkt. PN on line 2 contains ≤5 char, move yyww to the second line after the Mkt. PN.

3rd line is the backend revision, fab site, and lot code

The 'C' beside the square mark (Pb-Free mark) denotes the use of copper wire.

Example Marking Format: : CY7C1009D-10VXI

Line 1: CY7C1009D
Line 2: -10VXI 1513
Line 3: N 04 612604

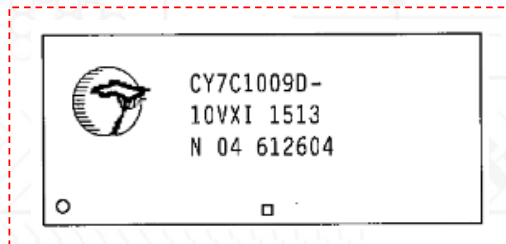

Note:

1. If Mkt PN is >12 characters, break the Mkt. PN after the 12th character then move the remaining characters to the second line.
2. If the dash ("-") falls in any character before the 12th character, break the Mkt. PN after the dash ("-") then move the remaining character to the second line.
3. Move the rrbff to the left followed by a blank (b) and the 6 digit mark lot number (nnnnnn)
4. For Non-MIA devices, mark last four digits of the assembly lot number (nnnn) beside the pin 1 indicator.

Packages :

- SOJ28 - 300/400 mils
- SOJ32 - 300/400 mils
- SOJ44 - 300/400 mils

SSOP 20L/SSOP 28L

Using Gold (Au) Wire



Lines 1 – 3: 15 characters per line

1st is the marketing part number

2nd line is the remaining marketing part number and datecode

3rd line is the backend revision, fab site, 'CYP' and lot code

Using Copper (Cu) Wire



Lines 1 – 3: 15 characters per line

1st is the marketing part number

2nd line is the remaining marketing part number and datecode

3rd line is the backend revision, fab site, 'CYP' and lot code

The 'C' beside the square mark (Pb-Free mark) denotes the use of copper wire.

Example Marking Format: : CY8C21334-24PVXI

Line 1: CY8C21334-
 Line 2: 24PVXI 1307
 Line 3: A 05 CYP 607009

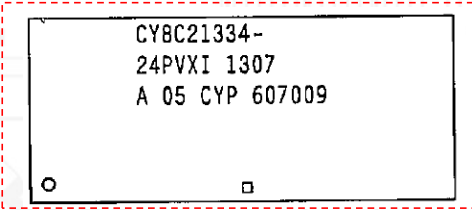

Packages :

- SOJ20 - 209 mils
- SOJ28 - 209 mils

SSOP 48L/SSOP 56L

Using Gold (Au) Wire



Lines 1 – 3: 19 characters per line

1st is the marketing part number

2nd line backend revision fab site, COO and date code.

3rd line is the 'CYP and the lot code

Using Copper (Cu) Wire



Lines 1 – 3: 19 characters per line

1st is the marketing part number

2nd line backend revision fab site, COO and date code.

3rd line is the 'CYP and the lot code

The 'C' beside the square mark (Pb-Free mark) denotes the use of copper wire.

Example Marking Format: : CY7C68013A-56PVXC

Line 1: CY7C68013A-56PVXC
 Line 2: B 04 CHI 1143
 Line 3: CYP 652398

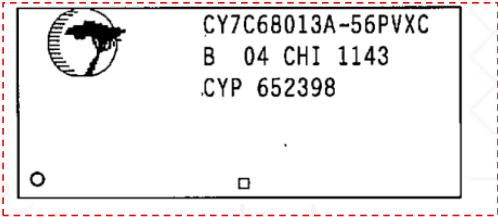

QSOP 20L/QSOP 28L

Using Gold (Au) Wire



1st and 2nd line (16 characters) is the marketing part number. If total Mkt Part number characters exceed 16 characters, then first 16 characters will be mark on the unit (first and 2nd line will be used). This will be followed by the datecode.

3rd line (14 characters) is the backend revision and fab site.

4th line is the 'CYP' and lot code.

Using Copper (Cu) Wire



1st and 2nd line (16 characters) is the marketing part number. If total Mkt Part number characters exceed 16 characters, then first 16 characters will be mark on the unit (first and 2nd line will be used). This will be followed by the datecode.

3rd line (14 characters) is the backend revision and fab site.

4th line is the 'CYP' and lot code.

The 'C' beside the square mark (Pb-Free mark) denotes the use of copper wire.

Example Marking Format: : CY7C60223-QXC

- Line 1: CY7C60223-
- Line 2: QXC 1043
- Line 3: A 05
- Line 4: CYP 653647

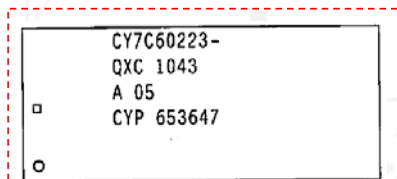

NOTES:

1. First 2-lines will be used for marketing part number
2. If dash (-) is used on the first 9-characters for marketing part numbers split the characters before the dash and wrap on 2nd line.
3. If dash is used on the 10th or 11th characters, ignore dash.

Packages :

- QSOP20 – 150mils
- QSIOP28 – 150mils

TSSOP 8L

Using Gold (Au) Wire

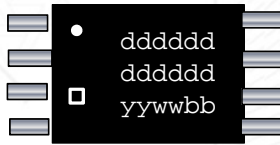

Lines 1 – 3: 6 characters per line
1st and 2nd line is the marketing part number
3rd line is the date code

Using Copper (Cu) Wire

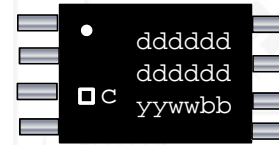

Lines 1 – 3: 6 characters per line
1st and 2nd line is the marketing part number
3rd line is the date code
The 'C' beside the square mark (Pb-Free mark) denotes the use of copper wire.

Example Marking Format: : CY25100ZXCF

Line 1: CY2510
Line 2: 0ZXCF
Line 3: 1125

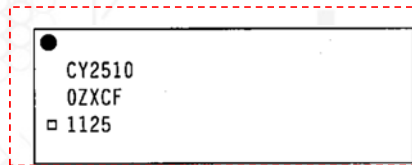

Note:

1. Requirement of "SIX DIGIT ASSEMBLY LOT NUMBER AND COUNTRY OF ORIGIN IS REQUIRED ON BACKSIDE MARKING"

Packages :

- TSSOP 8 – 173 mils

TSSOP 16L/TSSOP 14L

Using Gold (Au) Wire

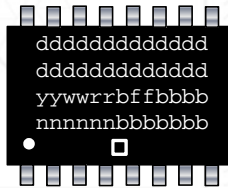

Lines 1 – 4: 13 characters per line

1st and 2nd line is the marketing part number. If total Mkt Part number characters exceed 13 characters, then first 13 characters will be mark on the unit (first and 2nd line will be used).

3rd line is the date code, backend revision, fab site

4th line is the lot code

Using Copper (Cu) Wire

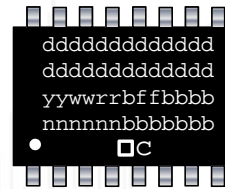

Lines 1 – 4: 13 characters per line

1st and 2nd line is the marketing part number. If total Mkt Part number characters exceed 13 characters, then first 13 characters will be mark on the unit (first and 2nd line will be used).

3rd line is the date code, backend revision, fab site

4th line is the lot code

The 'C' beside the square mark (Pb-Free mark) denotes the use of copper wire.

Example Marking Format: : CY23FS04ZXIT

Line 1: CY23FS04Z
Line 2: XI
Line 3: 1143 B 05
Line 4: 654340

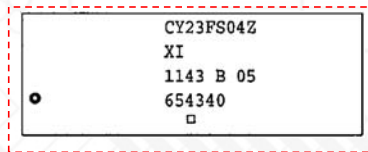

NOTES:

1. First 2-lines will be used for marketing part number
2. If dash (-) is used on the first 9-characters for marketing part numbers split the characters before the dash and wrap on 2nd line.
3. If dash is used on the 10th or 11th characters, ignore dash.

Packages :

- TSSOP16 – 173 mils
- TSSOP15 – 173 mils

TSSOP 20L/TSSOP 38L

Using Gold (Au) Wire

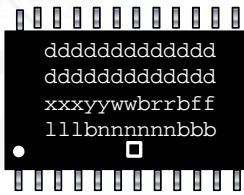

Lines 1 – 4: 13 characters per line

1st and 2nd line is the marketing part number. If total Mkt Part number characters exceed 13 characters, then first 13 characters will be mark on the unit (first and 2nd line will be used). If the total Mkt Part number characters is ≤13 characters, move the succeeding characters to line 2

3rd line is the COO, date code, backend revision, fab site

4th line is the 'CYP' and lot code

Using Copper (Cu) Wire



Lines 1 – 4: 13 characters per line

1st and 2nd line is the marketing part number. If total Mkt Part number characters exceed 13 characters, then first 13 characters will be mark on the unit (first and 2nd line will be used). If the total Mkt Part number characters is ≤13 characters, move the succeeding characters to line 2

3rd line is the COO, date code, backend revision, fab site

4th line is the 'CYP' and lot code

The 'C' beside the square mark (Pb-Free mark) denotes the use of copper wire.

Example Marking Format: : CY25404ZXI217

Line 1: CY25404ZXI217
 Line 2: TWN1301 B 04
 Line 3: CYP 602162

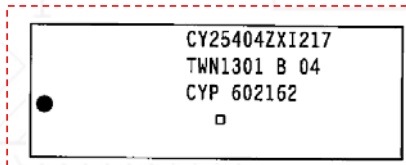

NOTES:

1. First 2-lines will be used for marketing part number
2. If dash (-) is used on the first 9-characters for marketing part numbers split the characters before the dash and wrap on 2nd line.
3. If dash is used on the 10th or 11th characters, ignore dash.

Packages :

- TSSOP20 – 173 mils
- TSSOP38 – 173 mils

TSSOP 20L/TSSOP 32L (REVERSE OPTION)

Using Gold (Au) Wire

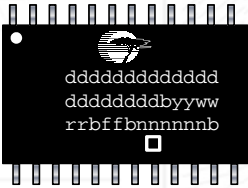

Lines 1 – 3: 13 characters per line

1st and 2nd line is the marketing part number. If total Mkt Part number characters exceed 13 characters, then first 13 characters will be mark on the unit (first and 2nd line will be used) followed by the datecode.

3rd line is the backend revision, fab site and the lot code

Using Copper (Cu) Wire



Lines 1 – 3: 13 characters per line

1st and 2nd line is the marketing part number. If total Mkt Part number characters exceed 13 characters, then first 13 characters will be mark on the unit (first and 2nd line will be used) followed by the datecode.

3rd line is the backend revision, fab site and the lot code

The 'C' beside the square mark (Pb-Free mark) denotes the use of copper wire.

Example Marking Format: : : CY62256VNLL-70ZRXI

Line 1: CY62256VNLL-
Line 2: 70ZRXI 1301
Line 3: ND 04 600295



NOTES:

1. First 2-lines will be used for marketing part number
2. If dash (-) is used on the first 9-characters for marketing part numbers split the characters before the dash and wrap on 2nd line.
3. If dash is used on the 10th or 11th characters, ignore dash.

TSOP II 32L to TSOP II 54L

Using Gold (Au) Wire

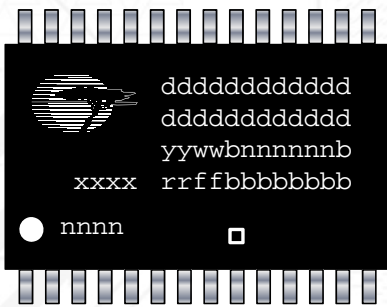

Lines 1 – 4: 12 characters per line
Line 5: 4 characters

1st and 2nd line is the marketing part number. If Mkt. PN is >12 characters, break the Mkt. PN after the 12th character then move the remaining characters to the second line. If Mkt. PN is ≤12 characters, move line 3 to line 2 then succeeding lines follows.

3rd line is the date code and lot code

4th line is the backend revision and fab site.

xxxx – Country of Origin (COO) – for Packages with no engraved COO.

Using Copper (Cu) Wire

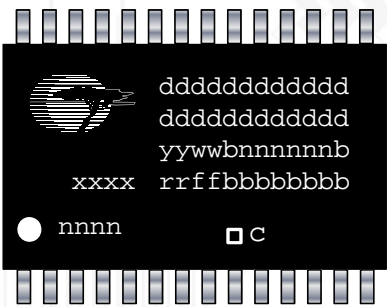

Lines 1 – 4: 12 characters per line
Line 5: 4 characters

1st and 2nd line is the marketing part number. If Mkt. PN is >12 characters, break the Mkt. PN after the 12th character then move the remaining characters to the second line. If Mkt. PN is ≤12 characters, move line 3 to line 2 then succeeding lines follows.

3rd line is the date code and lot code

4th line is the backend revision and fab site.

xxxx – Country of Origin (COO) – for Packages with no engraved COO.

The 'C' beside the square mark (Pb-Free mark) denotes the use of copper wire.

Example Marking Format: : CY7C1011DV33-10ZSXI

Line 1: CY7C1011DV33
Line 2: -10ZSXI
Line 3: 1301 600680
Line 4: PHI N 04

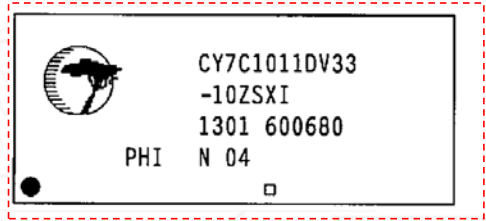

Note:

1. If the dash ("-") falls in any character before the 12th character, break the Mkt. PN after the dash ("-") then move the remaining character to the second line.
2. For Non-MIA devices, mark last four digits of the assembly lot number (nnnn) beside the pin 1 indicator.

- Packages :
- TSOP II 32 – 435/400 mils
 - TSOP II44 - 435/400 mils
 - TSOP II 54 - 435/400 mils



TSOP 28L/TSOP 48L

Using Gold (Au) Wire



Lines 1 – 3: 13 characters per line

1st line is the marketing part number.

2nd line is the marketing part number if > 13 chars and date code

3rd line is backend revision, fab site and the lot code

Using Copper (Cu) Wire



Lines 1 – 3: 13 characters per line

1st line is the marketing part number.

2nd line is the marketing part number if > 13 chars and date code

3rd line is backend revision, fab site and the lot code

The 'C' beside the square mark (Pb-Free mark) denotes the use of copper wire.

Example Marking Format: : CY62167EV30LL-45ZXI

Line 1: CY62167EV30LL
Line 2: -45ZXI 1101
Line 3: F 04 603731

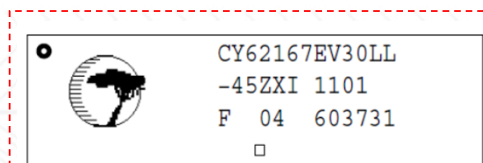

NOTES:

1. First 2-lines will be used for marketing part number
2. If total Mkt Part Number characters exceed 13 characters, then first characters will be mark on line 1 followed by remaining of the part number on line 2.
3. Date code follows after the part number.

Packages :

- TSOP28 – 767 mils
- TSOP48 - 767 mils

STSOP 32L

Using Gold (Au) Wire



Lines 1 – 3: 13 characters per line

1st line is the marketing part number

2nd line is the marketing part number if > 13 chars and datecode

3rd line is the backend revision, fab site and the lot code

Using Copper (Cu) Wire

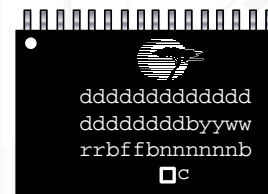

Lines 1 – 3: 13 characters per line

1st line is the marketing part number

2nd line is the marketing part number if > 13 chars and datecode

3rd line is the backend revision, fab site and the lot code

The 'C' beside the square mark (Pb-Free mark) denotes the use of copper wire.

Example Marking Format: : CY62148ESL-55ZAXI

Line 1: CY62148ESL-55
Line 2: ZAXI 1131
Line 3: F 04 636787

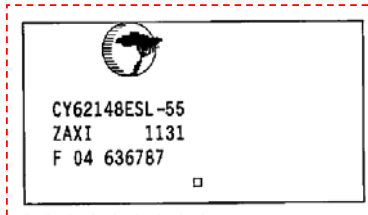

NOTES:

1. First 2-lines will be used for marketing part number
2. If total Mkt Part number characters exceed 13 characters, then first 13 characters will be mark on line 1 followed by remaining characters of the part number on line 2.
3. Date code follows after the part number

TQFP 32L to TQFP 144L

Using Gold (Au) Wire

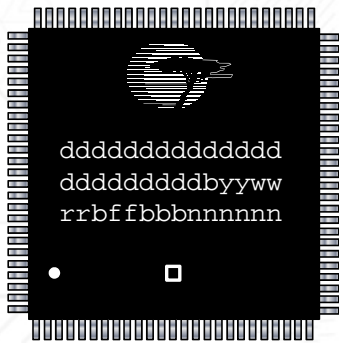

Lines 1 – 4: 14 characters per line

1st and 2nd line is the marketing part number. If Mkt. PN on line 2 contains ≤5 char, move yyww to the second line after the Mkt. PN.

3rd line is backend revision, fab site and lot code

Using Copper (Cu) Wire

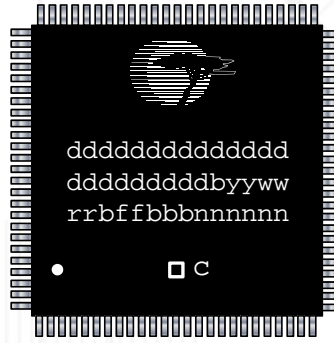

Lines 1 – 4: 14 characters per line

1st and 2nd line is the marketing part number. If Mkt. PN on line 2 contains ≤5 char, move yyww to the second line after the Mkt. PN.

3rd line backend revision, fab site And lot code

The 'C' beside the square mark (Pb-Free mark) denotes the use of copper wire.

Example Marking Format: : CY8C5468AXI-LP106

Line 1: CY8C5468AXI-
Line 2: LP106 1301
Line 3: A 04 600436

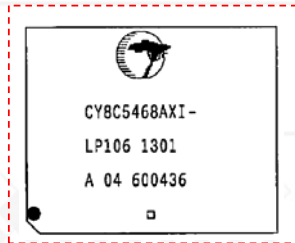

Note:

1. If length of Mkt Part Number exceeds the maximum number of characters on Line 1, split the Mkt Part Number after the dash and wrapping the rest on the second line.
2. For Non-MIA devices, mark last four digits of the assembly lot number (nnnn) beside the pin 1 indicator.

TQFP 160L to TQFP 388L

Using Gold (Au) Wire

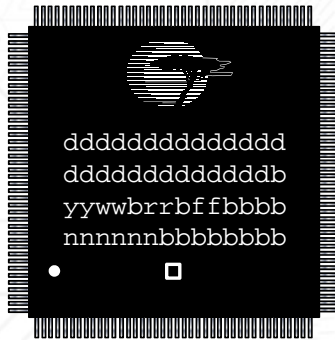

Lines 1 – 4: 14 characters per line

1st and 2nd line is the marketing part number. If Mkt. PN is ≤14 characters, move line 3 to line 2 then succeeding lines follows.

3rd line is the date code, backend revision and fab site

4th line is the lot code

Using Copper (Cu) Wire

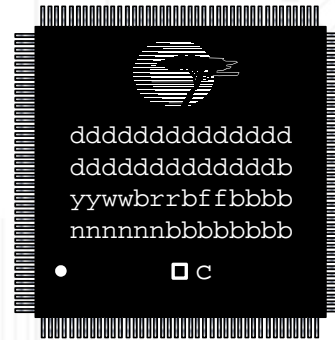

Lines 1 – 4: 14 characters per line

1st and 2nd line is the marketing part number. If Mkt. PN is ≤14 characters, move line 3 to line 2 then succeeding lines follows.

3rd line is the date code, backend revision and fab site

4th line is the lot code

The 'C' beside the square mark (Pb-Free mark) denotes the use of copper wire.

Example Marking Format: : CY37128VP160-125AXC

Example Marking Format: : CY37256P160-83AXC

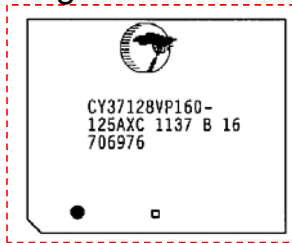

Line 1: CY37128VP1601-
Line 2: 125AXC 1137 B 6
Line 3: 706976



Example: (ASE Taiwan)

Line 1: CY37256P160-
Line 2: 83AXC TWN 1237
Line 3: B 16 630941

Note: *For ASET Assembled: COO is added after the part number*

Note:

1. If Mkt PN is >14 characters, break the Mkt. PN after the 14th character then move the remaining characters to the second line.
2. If the dash ("-") falls in any character before the 14th character, break the Mkt. PN after the dash ("-") then move the remaining character to the second line.
3. If Mkt. PN on line 2 contains ≤5 char, move yyww to the second line after the Mkt. PN separated with a blank then move the rrbff to the left followed by a blank (b) and the 6 digit mark lot number (nnnnnn)

TQFP 32L to TQFP 144L (EXPOSED PAD)

Using Gold (Au) Wire

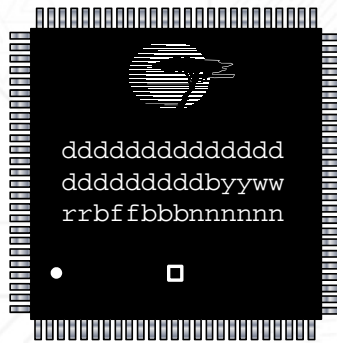

Lines 1 – 4: 14 characters per line

1st and 2nd line is the marketing part number. If Mkt. PN on line 2 contains ≤5 char, move yyww to the second line after the Mkt. PN.

3rd line is the date code, backend revision and fab site

4th line is the lot code

Using Copper (Cu) Wire

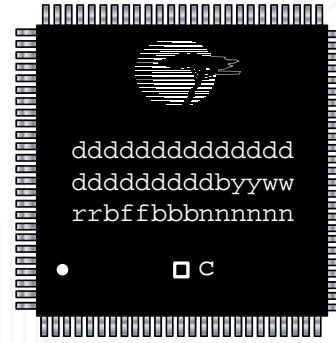

Lines 1 – 4: 14 characters per line

1st and 2nd line is the marketing part number. If Mkt. PN on line 2 contains ≤5 char, move yyww to the second line after the Mkt. PN.

3rd line is the date code, backend revision and fab site

4th line is the lot code

The 'C' beside the square mark (Pb-Free mark) denotes the use of copper wire.

Example Marking Format: : : CY525G101DX-AEXC

Line 1: CY525G101DX-
Line 2: AEXC 1307 B 04
Line 3: 605963



Note:

1. If length of Mkt Part Number exceeds the maximum number of characters on Line 1, split the Mkt Part Number after the dash and wrapping the rest on the second line.
2. For Non-MIA devices, mark last four digits of the assembly lot number (nnnn) beside the pin 1 indicator.

PQFP 32L to PQFP 144L

Using Gold (Au) Wire

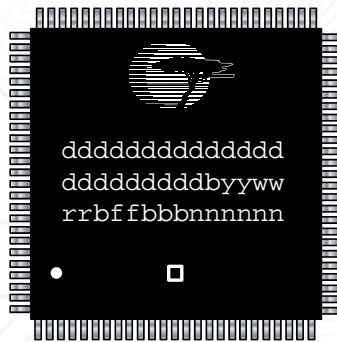

Lines 1 – 4: 14 characters per line

1st and 2nd line is the marketing part number. If Mkt. PN on line 2 contains ≤5 char, move yyww to the second line after the Mkt. PN

3rd line is the date code, backend revision and fab site

4th line is the lot code

Using Copper (Cu) Wire

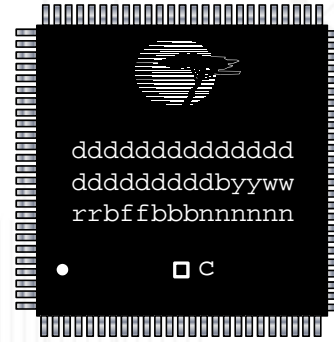

Lines 1 – 4: 14 characters per line

1st and 2nd line is the marketing part number. If Mkt. PN on line 2 contains ≤5 char, move yyww to the second line after the Mkt. PN

3rd line is the date code, backend revision and fab site

4th line is the lot code

The 'C' beside the square mark (Pb-Free mark) denotes the use of copper wire.

Example Marking Format: : CY7C136A-55NXI

Line 2: TWN1231 G 02
Line 3: 628291



Note:

1. If length of Mkt Part Number exceeds the maximum number of characters on Line 1, split the Mkt Part Number after the dash and wrapping the rest on the second line.
2. For Non-MIA devices, mark last four digits of the assembly lot number (nnnn) beside the pin 1 indicator.

PQFP 160L to PQFP 388L

Using Gold (Au) Wire

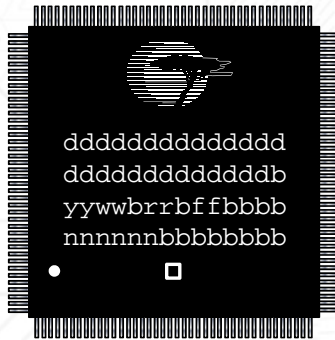

Lines 1 – 4: 14 characters per line

1st and 2nd line is the marketing part number

3rd line is the date code, backend revision and fab site

4th line is the lot code

Using Copper (Cu) Wire

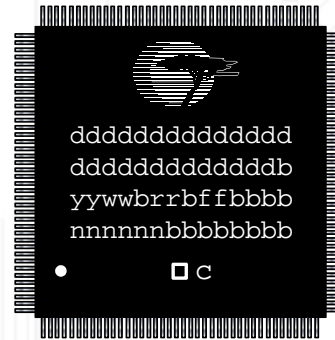

Lines 1 – 4: 14 characters per line

1st and 2nd line is the marketing part number

3rd line is the date code, backend revision and fab site

4th line is the lot code

The 'C' beside the square mark (Pb-Free mark) denotes the use of copper wire.

No Example Available

CQFP 52L to CQFP 144L

Using Gold (Au) Wire

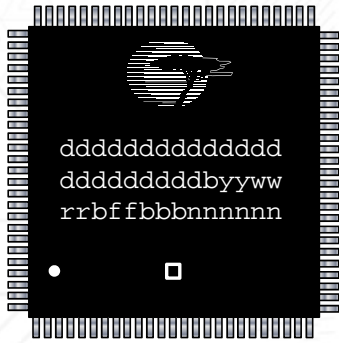

Lines 1 – 4: 14 characters per line

1st and 2nd line is the marketing part number. If Mkt. PN on line 2 contains ≤5 char, move yyww to the second line after the Mkt. PN

3rd line is the date code, backend revision and fab site

4th line is the lot code

Using Copper (Cu) Wire

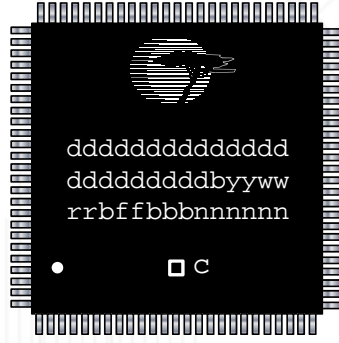

Lines 1 – 4: 14 characters per line

1st and 2nd line is the marketing part number. If Mkt. PN on line 2 contains ≤5 char, move yyww to the second line after the Mkt. PN

3rd line is the date code, backend revision and fab site

4th line is the lot code

The 'C' beside the square mark (Pb-Free mark) denotes the use of copper wire.

Example Marking Format: : : CY7C960A-UMB

Line 2: C THA0907 B 02
Line 3: 605251



Note:

1. If length of Mkt Part Number exceeds the maximum number of characters on Line 1, split the Mkt Part Number after the dash and wrapping the rest on the second line.
2. For Non-MIA devices, mark last four digits of the assembly lot number (nnnn) beside the pin 1 indicator.

CQFP 160L to CQFP 388L

Using Gold (Au) Wire

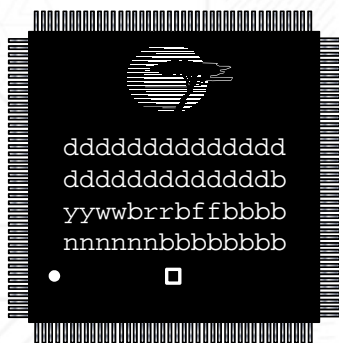

Lines 1 – 4: 14 characters per line

1st and 2nd line is the marketing part number

3rd line is the date code, backend revision and fab site

4th line is the lot code

Using Copper (Cu) Wire

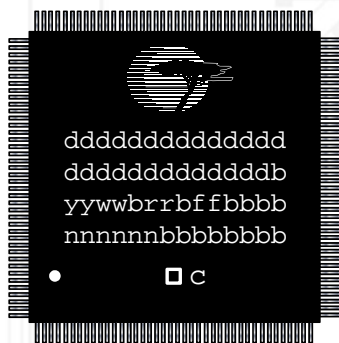

Lines 1 – 4: 14 characters per line

1st and 2nd line is the marketing part number

3rd line is the date code, backend revision and fab site

4th line is the lot code

The 'C' beside the square mark (Pb-Free mark) denotes the use of copper wire.

No Example Available

PDIP 8L

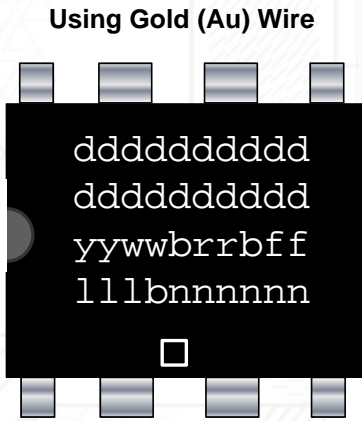

1st and 2nd line is the marketing part number.
 3rd line is the date code, backend revision and fab site
 4th line is the CYP and the lot code



1st and 2nd line is the marketing part number.
 3rd line is the date code, backend revision and fab site
 4th line is the CYP and the lot code
 The 'C' beside the square mark (Pb-Free mark) denotes the use of copper wire.

Example Marking Format: : CY8C24123A-24PXI

Line 1: CY8C24123
 Line 2: A-24PXI
 Line 3: 1231 B 04
 Line 4: CYP 629726

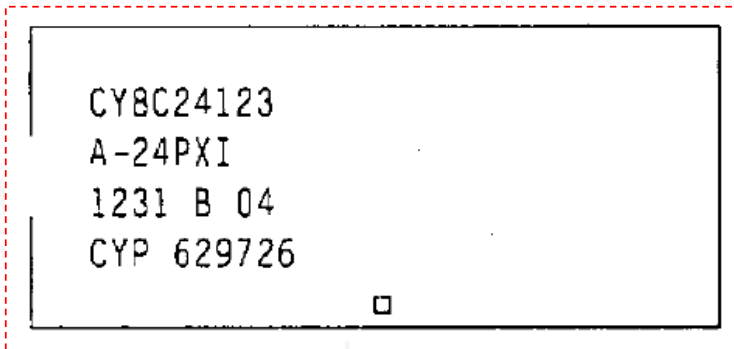

Packages :
 • PDIP8 – 300 mils

PDIP 16L to PDIP 64L

Using Gold (Au) Wire



16 characters per line

1st and 2nd line is the marketing part number.

3rd line is the date code, backend revision and fab site

4th line is "CYP" and the lot code

Using Copper (Cu) Wire



16 characters per line

1st and 2nd line is the marketing part number.

3rd line is the date code, backend revision and fab site

4th line is "CYP" and the lot code

The 'C' beside the square mark (Pb-Free mark) denotes the use of copper wire.

Example Marking Format: : CY8C24123A-24PXI

Line 1: CY8C24123
 Line 2: A-24PXI
 Line 3: 1331 B 04
 Line 4: CYP 632377

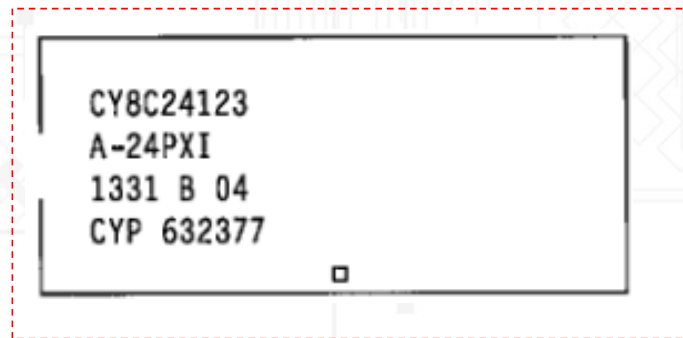

CERDIP 8L

Using Gold (Au) Wire

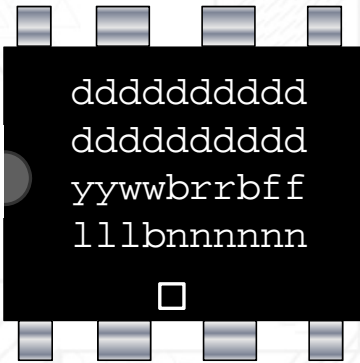

10 characters per line
1st and 2nd line is the marketing part number.
3rd line is the date code, backend revision and fab site
4th line is the CYP and the lot code

Using Copper (Cu) Wire

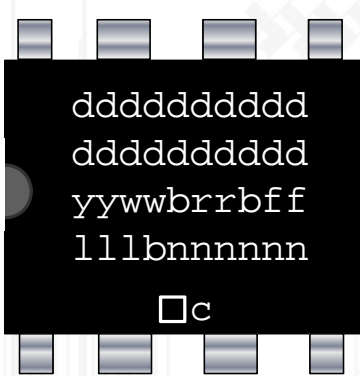

10 characters per line
1st and 2nd line is the marketing part number.
3rd line is the date code, backend revision and fab site
4th line is the CYP and the lot code
The 'C' beside the square mark (Pb-Free mark) denotes the use of copper wire.

No Example Available

Packages :
• CERDIP – 300 mils

CERDIP 16L to CERDIP 64L

Using Gold (Au) Wire



16 characters per line

1st and 2nd line is the marketing part number.

3rd line is the date code, backend revision and fab site

4th line is the lot code

Using Copper (Cu) Wire



16 characters per line

1st and 2nd line is the marketing part number.

3rd line is the date code, backend revision and fab site

4th line is the lot code

The 'C' beside the square mark (Pb-Free mark) denotes the use of copper wire.

No Example Available

Using Gold (Au) Wire

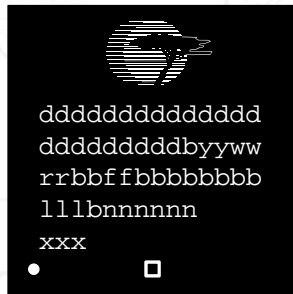

Lines 1 – 4: 14 characters per line

1st and 2nd line is the marketing part number. If Mkt. PN on line 2 contains ≤5 char, move yyww (date code) to the second line after the Mkt. PN.

3rd line is backend revision and fab site

4th line is the CYP and the lot code

5th line is the COO

Using Copper (Cu) Wire

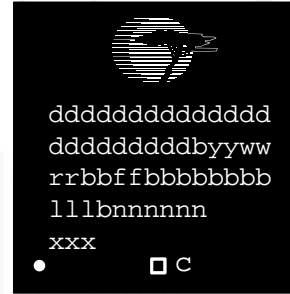

Lines 1 – 4: 14 characters per line

1st and 2nd line is the marketing part number. If Mkt. PN on line 2 contains ≤5 char, move yyww (date code) to the second line after the Mkt. PN.

3rd line is backend revision and fab site

4th line is the CYP and the lot code

5th line is the COO

The 'C' beside the square mark (Pb-Free mark) denotes the use of copper wire.

Example Marking Format: : : CY7C1412KV18-300BZXC

Note:

Package: BGA165

Assembly Location: ASE Taiwan

Line 1: CY7C1412KV18-
Line 2: 300BZXC
Line 3: TWN1319 K 33
Line 4: 622252

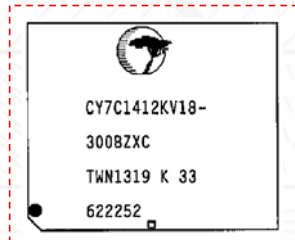

Assembly Location: CML Philippines

Line 1: CY7C1412KV18-
Line 2: 300BZXC 1219
Line 3: K 33 615123



1. If length of Mkt Part Number exceeds the maximum number of characters on Line 1, split the Mkt Part Number after the dash and wrapping the rest on the second line.
2. For Non-MIA devices, mark last four digits of the assembly lot number (nnnn) beside the pin 1 indicator.

Packages :

- BGA100, BGA144, BGA165, BGA172, BGA196, BGA119, BGA121, BGA209, BGA256, BGA272, BGA 484 (906mils)

BGA 292L/BGA 388L/BGA 484L

Using Gold (Au) Wire

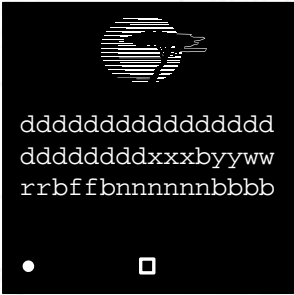

Lines 1 – 4: 16 characters per line

- 1st the marketing part number
- 2nd line is the marketing part number followed by the COO and datecode.
- 3rd line is the backend revision, fab site and lot code

Using Copper (Cu) Wire



Lines 1 – 4: 16 characters per line

- 1st the marketing part number
- 2nd line is the marketing part number followed by the COO and datecode
- 3rd line is the backend revision, fab site and lot code
- The 'C' beside the square mark (Pb-Free mark) denotes the use of copper wire.

Example Marking Format: : CYD36S36V18-200BGXC

Part Number:
 Line 1: CYD36S36V18-
 Line 2: 200BGXC TWN 1213
 Line 3: A 04 610305



Note:

1. If length of Mkt Part Number exceeds the maximum number of characters on Line 1, split the Mkt Part Number after the dash and wrapping the rest on the second line.

Packages :
 • BGA292, BGA388, BGA484 (1063 mils)

L2BGA 256L

Using Gold (Au) Wire

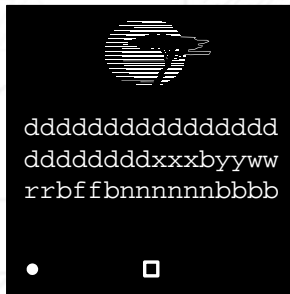

Lines 1 – 3: 16 characters per line

1st the marketing part number

2nd line is the marketing part number followed by the COO and datecode

3rd line is the backend revision, fab site and lot code

Using Copper (Cu) Wire

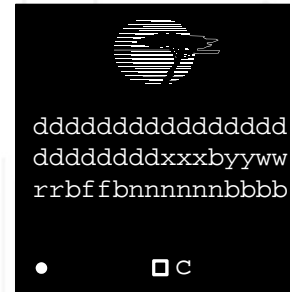

Lines 1 – 3: 16 characters per line

1st the marketing part number

2nd line is the marketing part number followed by the COO and datecode

3rd line is the backend revision, fab site and lot code

The 'C' beside the square mark (Pb-Free mark) denotes the use of copper wire.

Example Marking Format: : CYV15G0203TB-BGXC

Line 1: CYV15G0203TB-
Line 2: BGXC TWN 1301
Line 3: C 04 700273

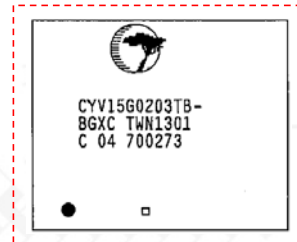

Note:

1. If length of Mkt Part Number exceeds the maximum number of characters on Line 1, split the Mkt Part Number after the dash and wrapping the rest on the second line.

FCBGA 361L (WITH HEAT SPREADER)

Using Gold (Au) Wire

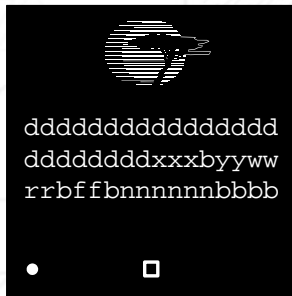

Lines 1 – 3: 16 characters per line

1st the marketing part number

2nd line is the marketing part number followed by the COO and datecode

3rd line is the backend revision, fab site and lot code

Using Copper (Cu) Wire

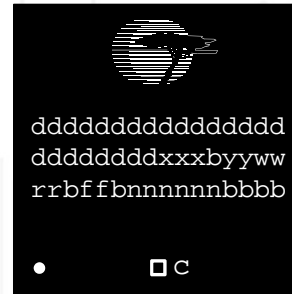

Lines 1 – 3: 16 characters per line

1st the marketing part number

2nd line is the marketing part number followed by the COO and datecode

3rd line is the backend revision, fab site and lot code

The 'C' beside the square mark (Pb-Free mark) denotes the use of copper wire.

No Example Available

BGA 36L to BGA 48L

Using Gold (Au) Wire

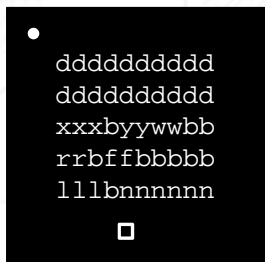

Lines 1 – 5: 10 characters per line

1st and 2nd line is the marketing part number

3rd line is the COO, and date code

4th line is the backend revision and fab site

5th line is 'CYP' and lot code

Using Copper (Cu) Wire

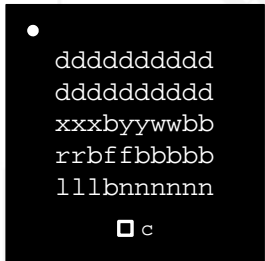

Lines 1 – 5: 10 characters per line

1st and 2nd line is the marketing part number

3rd line is the COO, and date code

4th line is the backend revision and fab site

5th line is 'CYP' and lot code

The 'C' beside the square mark (Pb-Free mark) denotes the use of copper wire.

Example Marking Format: : CY62147EV30LL-45BVXI

Line 2: 0LL-45BVXI
 Line 3: PHI 1131
 Line 4: F 04
 Line 5: CYP 642602

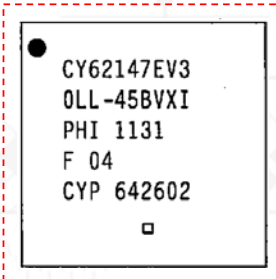

Note:

1. If length of Mkt Part Number exceeds the maximum number of characters on Line 1, split the Mkt Part Number after the dash and wrapping the rest on the second line.

BGA 36L/BGA 48L/BGA 60L/BGA 121L

Using Gold (Au) Wire



Lines 1 – 4: 13 characters per line

1st line is the marketing part number

2nd line is the remaining marketing part number and datecode

3rd line is the backend revision, fab site and COO

4th line is 'CYP' and lot code

Using Copper (Cu) Wire



Lines 1 – 4: 13 characters per line

1st line is the marketing part number

2nd line is the remaining marketing part number and datecode

3rd line is the backend revision, fab site and COO

4th line is 'CYP' and lot code

The 'C' beside the square mark (Pb-Free mark) denotes the use of copper wire.

Example Marking Format: : CY14V101LA-BA45XI

Example Marking Format: : CYUSB3035-BZXI

Line 1: CY14V101LA-BA
Line 2: 45XI 1101
Line 3: C 04 PHI
Line 4: CYP 601532

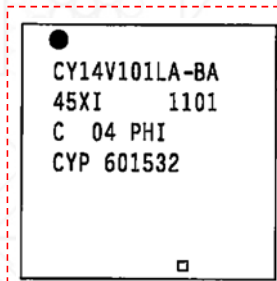

Part Number: CYUSB3035-BZXI
Package: BGA121

Assembly Location: ASE Taiwan

Line 1: CYUSB3035-BZX
Line 2: I 1331
Line 3: A 33 TWN
Line 4: CYP 630375

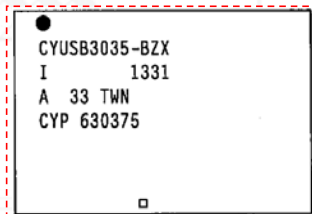

Assembly Location: CML Philippines

Line 1: CYUSB3035-BZX
Line 2: I 1231
Line 3: A 33 PHI
Line 4: CYP 629999

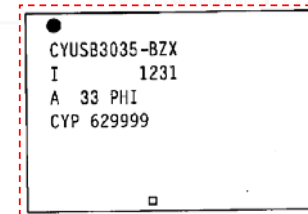

VFBGA 56L/VFBGA 84L/VFBGA 100L

Using Gold (Au) Wire

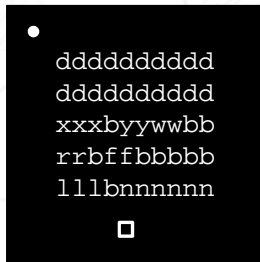

Lines 1 – 5: 10 characters per line

1st and 2nd line is the marketing part number

3rd line is the COO, and date code

4th line is the backend revision and fab site

5th line is 'CYP' and lot code

Using Copper (Cu) Wire



Lines 1 – 5: 10 characters per line

1st and 2nd line is the marketing part number

3rd line is the COO, and date code

4th line is the backend revision and fab site

5th line is 'CYP' and lot code

The 'C' beside the square mark (Pb-Free mark) denotes the use of copper wire.

Example Marking Format: : CYDMX256A16-90BVXI

Line 1: CYDMX256A1
 Line 2: 6-90BVXI
 Line 3: PHI 1301
 Line 4: A 04
 Line 5: 601268

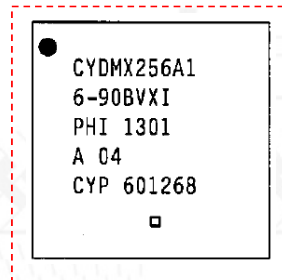

Note:

1. If length of Mkt Part Number exceeds the maximum number of characters on Line 1, split the Mkt Part Number after the dash and wrapping the rest on the second line.

VFBGA 60L/VFBGA 70L

Using Gold (Au) Wire

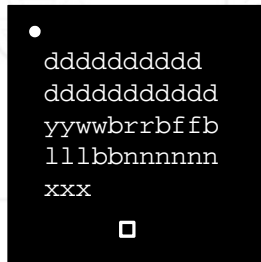

Line 1: 10 characters
 Lines 2 – 4: 11 characters per line
 Line 5: 3 characters

1st and 2nd line is the marketing part number

3rd line is the date code, backend revision and fab site

4th line is CYP' and lot code

5th line is the COO

Using Copper (CuPd) Wire

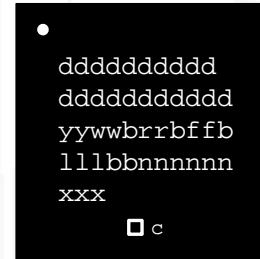

Line 1: 10 characters
 Lines 2 – 4: 11 characters per line
 Line 5: 3 characters

1st and 2nd line is the marketing part number

3rd line is the date code, backend revision and fab site

4th line is CYP' and lot code

5th line is the COO

Example Marking Format: : CY8CTMA463-60BUI

Line 1: CY8CTMA463
 Line 2: -60BUI
 Line 3: 1249 B 04
 Line 4: CYP 639287
 Line 5: TWN

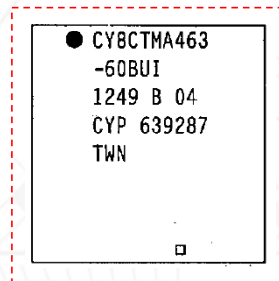

Note:

1. If length of Mkt Part Number exceeds the maximum number of characters on Line 1, split the Mkt Part Number after the dash and wrapping the rest on the second line.

Packages :

- VFBGA 60/VFBGA70 – 216 mils

UFBGA 48L

Using Copper (Cu) Wire



1st line (7characters) is the marketing part number

2nd line (7characters) is the marketing part number.

3rd line (7characters) is the marketing part number.

4th line (7 characters) is the datecode and lot code

5th line (4 characters) is the lotcode

The 'C' beside the square mark (Pb-Free mark) denotes the use of copper wire.

Example Marking Format: : CYTMA525-48BUI25ZZ

Line 1: CYTMA52
Line 2: 5-48BUI
Line 3: 25ZZ
Line 4: 1419 61
Line 5: 7493

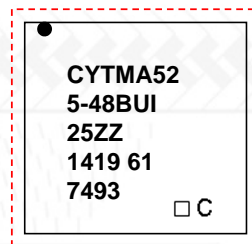

Note:

1. If length of Mkt Part Number exceeds the maximum number of characters on Line 1, split the Mkt Part Number after the dash and wrapping the rest on the second and third line.

UFBGA 60L/UFBGA 70L

Using Gold (Au) Wire

```

● dddddddddd
  dddddddddd
  yywwbrrffbb
  111bnnnnnbn
  xxx
  □
    
```

1st line (10 characters) is the marketing part number

2nd line (11 characters) is the marketing part number. If Mkt. PN on line 2 contains ≤5 char, move yyww to the second line after the Mkt. PN separated with a blank then move the rrbff to the next line.

3rd line (11 characters) is the datecode, backend revision and fab site

4th (11 characters) line is 'CYP' and lot code

5th line (3 characters) is the COO

Using Copper (Cu) Wire

```

● dddddddddd
  dddddddddd
  yywwbrrffbb
  111bnnnnnbn
  xxx
  □ c
    
```

1st line (10 characters) is the marketing part number

2nd line (11 characters) is the marketing part number. If Mkt. PN on line 2 contains ≤5 char, move yyww to the second line after the Mkt. PN separated with a blank then move the rrbff to the next line.

3rd line (11 characters) is the datecode, backend revision and fab site

4th (11 characters) line is 'CYP' and lot code

5th line (3 characters) is the COO

The 'C' beside the square mark (Pb-Free mark) denotes the use of copper wire.

Example Marking Format: : CY8CTMA463-60BUI

Line 2: -60BUI
 Line 3: 1249 B 04
 Line 4: CYP 639287
 Line 5: TWN

```

● CY8CTMA463
  -60BUI
  1249 B 04
  CYP 639287
  TWN
  □
    
```

Note:

1. If length of Mkt Part Number exceeds the maximum number of characters on Line 1, split the Mkt Part Number after the dash and wrapping the rest on the second line.

Packages :

- UFBGA 60/UFBGA70 – 216 mils

UFBGA 84L

Using Gold (Au) Wire

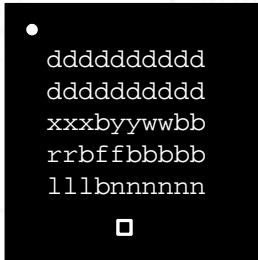

Lines 1 – 4: 10 characters per line

1st line is the marketing part number

2nd line is the remaining marketing part number

3rd line is the COO and the date code.

4th line is the backend revision, fab site

5th line is 'CYP' and lot code

Using Copper (Cu) Wire

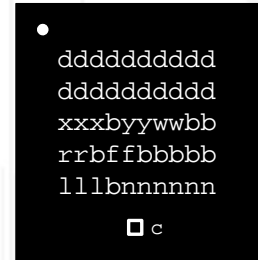

Lines 1 – 4: 10 characters per line

1st line is the marketing part number

2nd line is the remaining marketing part number

3rd line is the COO and the date code.

4th line is the backend revision, fab site

5th line is 'CYP' and lot code

The 'C' beside the square mark (Pb-Free mark) denotes the use of copper wire.

Example Marking Format: : CY8CTMA768BUI-23

Line 1: CY8CTMA768
Line 2: BUI-23
Line 3: TWN 1249
Line 4: B 04
Line 5: CYP 640128

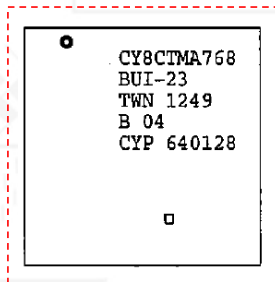

Packages :

- UFBGA 84L – 236 mils

PLCC 24L TO PLCC 32L

Using Gold (Au) Wire



Lines 1 – 4: 11 characters per line

1st line is the marketing part number

2nd line is the remaining marketing part number and datecode

3rd line is the backend revision and fab site

4th line is 'CYP' and the lot code

Using Copper (Cu) Wire

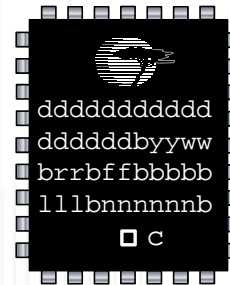

Lines 1 – 4: 11 characters per line

1st line is the marketing part number

2nd line is the remaining marketing part number and datecode

3rd line is the backend revision and fab site

4th line is 'CYP' and the lot code

The 'C' beside the square mark (Pb-Free mark) denotes the use of copper wire.

Example Marking Format: : CY7B991V-5JXC

-23

Line 1: CY7B991V-
Line 2: 5JXC 11243
Line 3: V 02
Line 4: CYP 637742

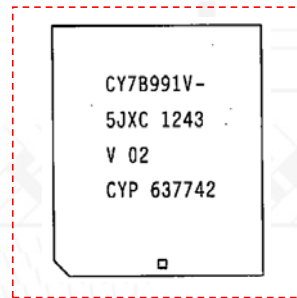

Note:

1. If length of Mkt Part Number exceeds the maximum number of characters on Line 1, split the Mkt Part Number after the dash and wrapping the rest on the second line.

PLCC 44L TO PLCC 84L

Using Gold (Au) Wire

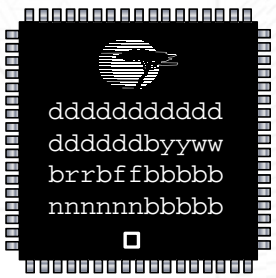

- Lines 1 – 4: 11 characters per line
- 1st line is the marketing part number
- 2nd line is the remaining marketing part number and datecode
- 3rd line is the backend revision and fab site
- 4th line is the lot code

Using Copper (Cu) Wire

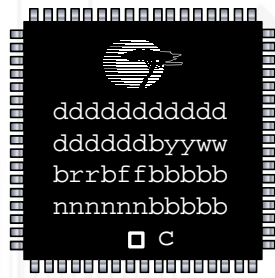

- Lines 1 – 4: 11 characters per line
- 1st line is the marketing part number
- 2nd line is the remaining marketing part number and datecode
- 3rd line is the backend revision and fab site
- 4th line is the lot code
- The 'C' beside the square mark (Pb-Free mark) denotes the use of copper wire.

Example Marking Format: : CY7C144E-15JXI

- Line 1: CY7C144E-
- Line 2: 15JXI 1243
- Line 3: NF 04
- Line 4: 637415

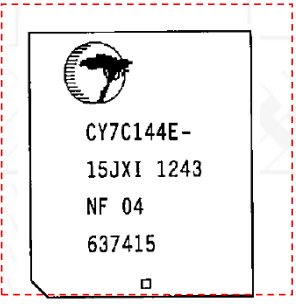

Note:

1. If length of Mkt Part Number exceeds the maximum number of characters on Line 1, split the Mkt Part Number after the dash and wrapping the rest on the second line.

LCC 04L TO LCC 06L

Using Gold (Au) Wire

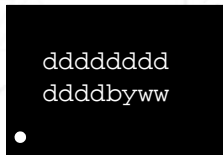

ddddddd
dddbyww

Lines 1 – 2: 8 characters per line

1st and 2nd line is the marketing part number

2nd line is the remaining marketing part number and last 3 digits of datecode (yww)

Example Marking Format: : CY2XF32FLXIT I

Line 1: CY2XF32F
Line 2: LXI 213

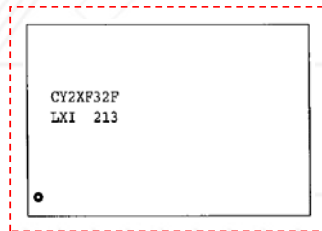

CY2XF32F
LXI 213

QFN 8L

Using Gold (Au) Wire



1st line (3 characters) is the 7th, 8th and 9th characters of marketing part number

2nd line (3 characters) is the last three digits of assembly lot number

Example Marking Format: CY22U1SCALGXC-00

Line 1: SCA
Line 2: nnn

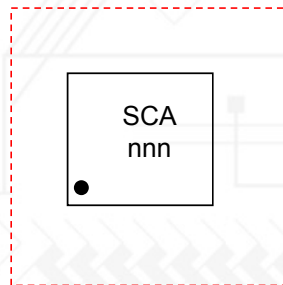

Packages :
• QFN8 = 3x3 mm

QFN 16L

Using Gold (Au) Wire



1st line (4 characters) is the 4 digit marketing part number before the dash (-)

2nd line (4 characters) is the datecode

3rd line (4 characters) is the last 4 digits of the lot number

Using Copper (Cu) Wire

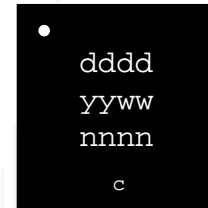

1st line (4 characters) is the 4 digit marketing part number before the dash (-)

2nd line (4 characters) is the datecode

3rd line (4 characters) is the last 4 digits of the lot number

The 'C' denotes the use of copper wire.

Example Marking Format: CY8C20045-24LKXI

Line 1: 0045
Line 2: 1225
Line 3: 3650

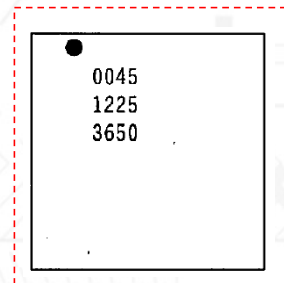

Packages :
• QFN16L = 3x3 mm

QFN 16L/24L/28

Using Gold (Au) Wire



1st line (4 characters) is the marketing part number

2nd line (6 characters) is the marketing part number

3rd line (6 characters) is the date code and the first digit of the lot code

4th line (4 characters) is the last 4 digit if lot code

Using Copper (Cu) Wire



1st line (4 characters) is the marketing part number

2nd line (6 characters) is the marketing part number

3rd line (6 characters) is the date code and the first digit of the lot code

4th line (4 characters) is the last 4 digit if lot code

The 'C' beside the square mark (Pb-Free mark) denotes the use of copper wire.

Example Marking Format: CY8C20346-24LQXI

Line 1: CY8C
Line 2: 20346-
Line 3: 1213 6
Line 4: 3312

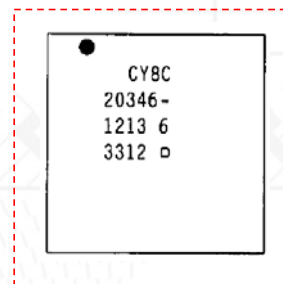

Note:

1. First two lines will be mark with Marketing Part numbers only. If Marketing Part number exceeds 10 characters, Mark only the first 10 characters of the marketing part number. Ignore splitting and wrap first 10 characters over the first two lines.

QFN/DFN 8L/16L/20L

Using Gold (Au) Wire

```
• dddddd  
  dddddd  
  yywwbxxx  
  nnnnnn  
  □
```

- 1st line (7 characters) is the marketing part number
- 2nd line (8 characters) is the marketing part number
- 3rd line (8 characters) is the date code and the first digit of the lot code
- 4th line (6 characters) is the lot code

Using Copper (Cu) Wire

```
• dddddd  
  dddddd  
  yywwbxxx  
  nnnnnn  
  □ c
```

- 1st line (7 characters) is the marketing part number
 - 2nd line (8 characters) is the marketing part number
 - 3rd line (8 characters) is the date code and the first digit of the lot code
 - 4th line (6 characters) is the lot code
- The 'C' beside the square mark (Pb-Free mark) denotes the use of copper wire.

Example Marking Format: CY14B101Q2-LHXI

- Line 1: CY14B10
- Line 2: 1Q2-LHXI
- Line 3: 1207 TWN
- Line 4: 605256

```
• CY14B10  
  1Q2-LHXI  
  1207 TWN  
  605256 □
```



QFN 28L/32L/36L/44L

Using Gold (Au) Wire

```

• dddddd
  dddddd
  yywwbxxx
  nnnnnn
  AAA
  □
    
```

- 1st line (7 characters) is the marketing part number
- 2nd line (8 characters) is the marketing part number
- 3rd line (8 characters) is the date code and the first digit of the lot code
- 4th line (6 characters) is the lot code
- 5th line is the Strip ID for CML Autoline assembled only

Using Copper (Cu) Wire

```

• dddddd
  dddddd
  yywwbxxx
  nnnnnn
  AAA
  □ c
    
```

- 1st line (7 characters) is the marketing part number
- 2nd line (8 characters) is the marketing part number
- 3rd line (8 characters) is the date code and the first digit of the lot code
- 4th line (6 characters) is the lot code
- 5th line is the Strip ID for CML Autoline assembled only
- The 'C' beside the square mark (Pb-Free mark) denotes the use of copper wire.

Example Marking Format: CY8CTST242-LQI-01

Line 1: CY8CTST
 Line 2: 242-LQI-
 Line 3: 1301 PHI
 Line 4: 600815
 Line 5: AAA

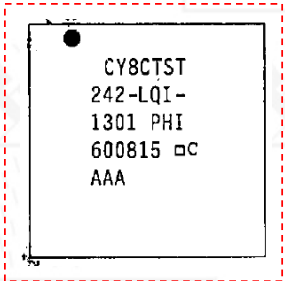

NOTES:

1. First 2-lines will be used for marketing part number
2. If dash (-) is used on the first 8-characters for marketing part numbers split the characters before the dash and wrap on 2nd line.
3. If dash is used on the 9th or 10th characters, ignore dash.
4. If total Mkt Part number characters exceed 15 characters, then first 15 characters will be mark on the unit (first and 2nd line will be used)



QFN 40L/48/56L

Using Gold (Au) Wire

```

● dddddd
  dddddd
  yywwbrbff
  111nnnnn
  xxx
  AAA □
    
```

1st line (8 characters) is the marketing part number

2nd line (9 characters) is the marketing part number

3rd line (9 characters) is the date code, backend revision and fab site

4th line (9 characters) is 'CYP' and lot code

5th line is the COO

6th line (3 characters) is the Strip ID for CML Autoline assembled only

Using Copper (Cu) Wire

```

● dddddd
  dddddd
  yywwbrbff
  111nnnnn
  xxx
  AAA □ c
    
```

1st line (8 characters) is the marketing part number

2nd line (9 characters) is the marketing part number

3rd line (9 characters) is the date code, backend revision and fab site

4th line (9 characters) is 'CYP' and lot code

5th line is the COO

6th line (3 characters) is the Strip ID for CML Autoline assembled only

The 'C' beside the square mark (Pb-Free mark) denotes the use of copper wire.

Example Marking Format: CY8CTMA400-48LQI

Line 1: CY8CTMA4
 Line 2: 00-48LQI
 Line 3: 1307 B 04
 Line 4: CYP606450
 Line 5: PHI
 Line 6: AAA

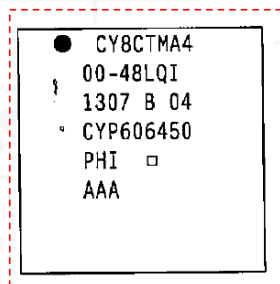

NOTES:

1. First 2-lines will be used for marketing part number
2. If dash (-) is used on the first 8-characters for marketing part numbers split the characters before the dash and wrap on 2nd line.
3. If dash is used on the 9th or 10th characters, ignore dash.
4. If total Mkt Part number characters exceed 17 characters, then first 17 characters will be mark on the unit (first and 2nd line will be used)

Packages :

- QFN40/48/56 – 6X6 mm

Reference: 37-00001, Figure 52



QFN 48L/56L

Using Gold (Au) Wire



Lines 1 – 4: 13 characters per line

1st line is the marketing part number

2nd line is the remaining marketing part number and datecode

3rd line is the backend revision, fab site and COO

4th line is 'CYP' and lot code

5th line (3 characters) is the strip ID applicable only for CML Autoline Assembled

Using Copper (Cu) Wire

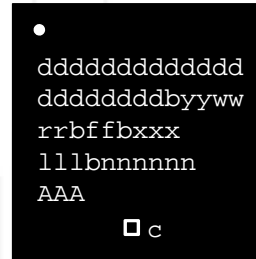

Lines 1 – 4: 13 characters per line

1st line is the marketing part number

2nd line is the remaining marketing part number and datecode

3rd line is the backend revision, fab site and COO

4th line is 'CYP' and lot code

5th line (3 characters) is the strip ID applicable only for CML Autoline Assembled

The 'C' beside the square mark (Pb-Free mark) denotes the use of copper wire.

Example Marking Format: CY8C3445LTI-089

Line 1: CY8C3445LTI-0
 Line 2: 89 1307
 Line 3: A 04 PHI
 Line 4: CYP 610578
 Line 5: AAA

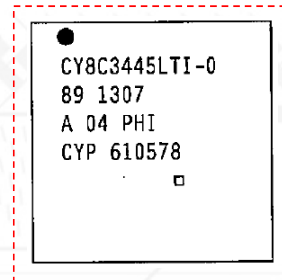

Packages :

- QFN48 – 7XX mm
- QFN56 – 8X8 mm

QFN 48L/56L

Using Gold (Au) Wire

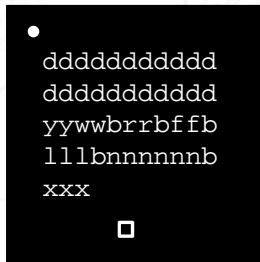

Lines 1 – 4: 11 characters per line

1st and 2nd line is the marketing part number

3rd line is the date code, backend revision and fab site

4th line is 'CYP' and lot code

5th line (3 characters) is COO

Using Copper (Cu) Wire

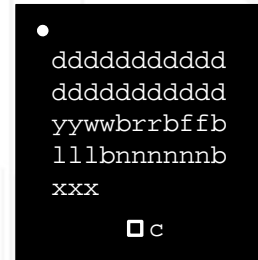

Lines 1 – 4: 11 characters per line

1st and 2nd line is the marketing part number

3rd line is the date code, backend revision and fab site

4th line is 'CYP' and lot code

5th line (3 characters) is COO

The 'C' beside the square mark (Pb-Free mark) denotes the use of copper wire.

Example Marking Format: : CY8C3246LTI-128

Line 1: CY8C3246LTI
Line 2: -128
Line 3: 1125 A 04
Line 4: CYP 632770
Line 5: PHI

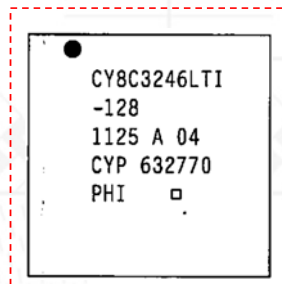

Packages :
• QFN 68L – 8x8x mm

QFN 88L

Using Gold (Au) Wire

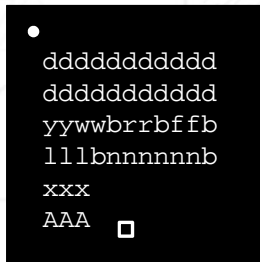

- Lines 1 – 4: 11 characters per line
- 1st and 2nd line is the marketing part number
- 3rd line is the date code, backend revision and fab site
- 4th line is 'CYP' and lot code
- 5th line (3 characters) is COO
- 6th line (3 characters) is the strip ID applicable only for CML Autoline Assembled

Using Copper (Cu) Wire

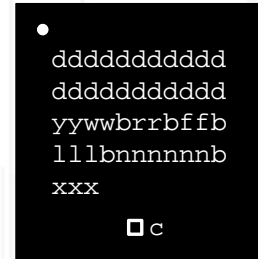

- Lines 1 – 4: 11 characters per line
- 1st and 2nd line is the marketing part number
- 3rd line is the date code, backend revision and fab site
- 4th line is 'CYP' and lot code
- 5th line (3 characters) is COO
- 6th line (3 characters) is the strip ID applicable only for CML Autoline Assembled
- The 'C' beside the square mark (Pb-Free mark) denotes the use of copper wire.

Example Marking Format: : CY8CTMA884LTI-13

- Line 1: CY8CTMA884L
- Line 2: TI-13
- Line 3: 1131 C 04
- Line 4: CYP 640430
- Line 5: PHI
- Line 6: AAA

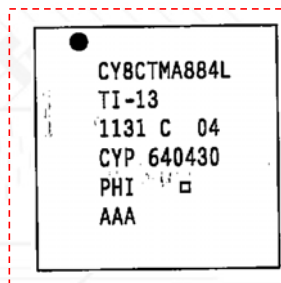

- Packages :
- QFN88 – 8x8 mm

WLCSP 30L

Using Gold (Au) Wire

• ddd
ddd
yww
nnnn □

1st and 2nd line (3 characters)
is the marketing part number

3rd line (3 characters) is the
date code – ‘yww’

4th line (4 characters)
is the last 4 digit if lot code

Example Marking Format: : CY8C20634-12FDXIT

Line 1: CY-
Line 2: 634
Line 3: 949
Line 4: 3041

• CY-
634
949
3041 □

Packages :

- WLCSP30 – 1.85X2.31 mm

WLCSP 30L

Using Gold (Au) Wire



1st and 2nd line (9 characters) is the marketing part number

3rd line (9 characters) is the remaining part number and the date code

4th line (4 characters) is the backend revision fn fab site.

5th line (6 characters) is the lot code

Example Marking Format: : CY8C20767-24FDXCT

Line 1: CY8C20767
Line 2: -24FDXC
Line 3: 1201
Line 4: A 05
Line 5: 600369

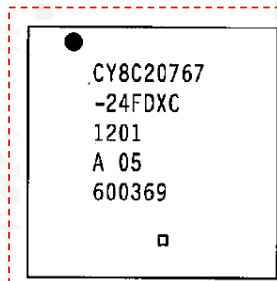

Packages :

- WLCSP30 – 2.2x2.3 mm

WLCSP 49L

Using Gold (Au) Wire



Line 1 – 3 (10 characters) is the marketing part number

4th line (8 characters) is the COO and datecode

5th line (6 characters) is the lot code

Example Marking Format : : CY8C20767-24FDXCT

Example:

Part Number: CY8CTMA300E-49FNXI
Line 1: CY8CTMA300
Line 2: E-49FNXI
Line 3: TWN 1207
Line 4: 601740

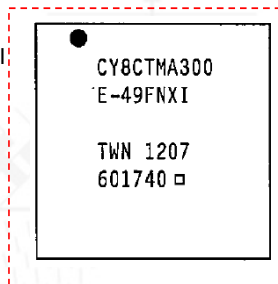

Note:

1. First three lines will be mark with Marketing Part numbers only. If Marketing Part number exceeds 10 characters, Mark only the first 10 characters of the marketing part number. Ignore splitting and wrap first 10 characters over the first three lines.

Packages :

- WLCSP49 – 3.2.2x3.2 mm

WLCSP 49L/60L/34L/DFN 14L

Using Gold (Au) Wire

```
• dddddddddd  
  dddddddddd  
  dddddddddd  
  xxxbyyww  
  rrf  
  nnnnnn  
  □
```

Line 1 – 3 (10 characters) is the marketing part number

4th line (8 characters) is the COO and datecode

5th line (4 characters) is the backend revision and fab site

6th line (6 characters) is the lot code

No Example Available

Packages :

- WLCSP49/60 – 3.7x3.8 mm
- WLCSP34 – 2.495x2.44 mm
- DFN14 – 2.5x3.5 mm

WLCSP 81L/131L

Using Gold (Au) Wire

• dddd
dddddd
yywbn
nnnn
□

1st line (4 characters) is the marketing part number

2nd line (6 characters) is the marketing part number

3rd line (6 characters) is the date code and the first digit of the lot code

4th line (4 characters) is the last 4 digit if lot code

Using Copper (Cu) Wire

• dddd
dddddd
yywbn
nnnn
□ c

1st line (4 characters) is the marketing part number

2nd line (6 characters) is the marketing part number

3rd line (6 characters) is the date code and the first digit of the lot code

4th line (4 characters) is the last 4 digit if lot code

The 'C' beside the square mark (Pb-Free mark) denotes the use of copper wire.

Example Marking Format : : CYWB0124ABX-FDXIT

Line 1: CYWB
Line 2: 0124AB
Line 3: 1101 6
Line 4: 0795

• CYWB
0124AB
1101 6
0795
□

Note:

1. First two lines will be mark with Marketing Part numbers only. If Marketing Part number exceeds 10 characters, Mark only the first 10 characters of the marketing part number. Ignore splitting and wrap first 10 characters over the first two lines.

WLCSP 35L/60L/72L

Using Gold (Au) Wire

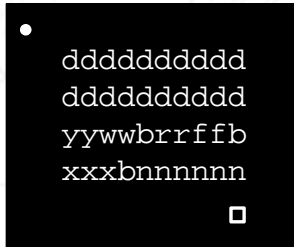

1st line (10 characters) is the marketing part number

2nd line (10 characters) is the marketing part number

3rd line (10 characters) is the date code , backend part and Fab location

4th line (10 characters) is the country of origin, and mark lot number

No Example Available

Reference: 37-00001
Figure 127

FRAM PARTS



FBGA 48L

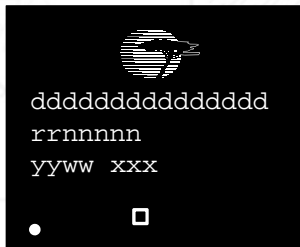

Line 1: Marketing Part Number

Line 2: **rrnnnnn**

where:

rr – BE Part rev Code (can be 1 or 2 characters)

nnnnnn – Cy assembly lot#

Line 3: **yyww** - Date Code, **xxx** – Country of origin

Example Marking Format: : FM28V402-BGC

Line 1: FM28V402-BGC

Line 2: A 618477

Line 3: C 1319 TWN

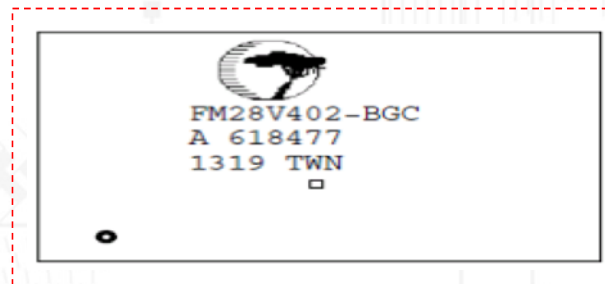

Reference: 37-00001, Figure 50
PIN135228

DFN 8L

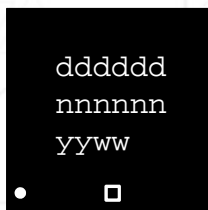

Line 1: Truncated Marketing Part Number

Line 2: nnnnnn - Cy assembly lot#

Line 3: yyww - Date Code

➤ 3x3mm 8 lead TDFN will NOT have square mark

Example Marking Format: : FM24CL64B-DG

Line 1: R4L64B
Line 2: 626151
Line 3: 1325

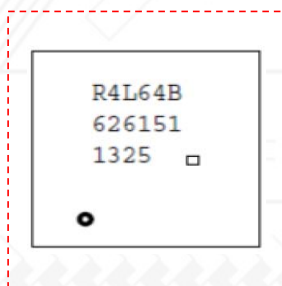

Reference: 37-00001, Figure 48

PIN135228

PDIP 8L

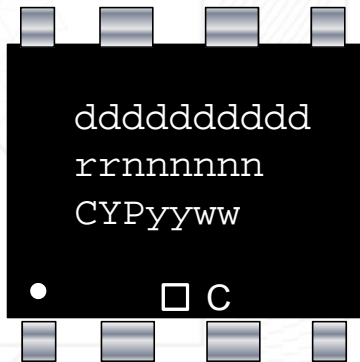

Line 1: Marketing Part Number

Line 2: rrrnnnnn

where:

rr - BE Part Rev Code (can be 1 or 2 characters)

nnnnnn - Cy assembly lot#

Line 3: CYPyyww

where:

CYP - Cypress

yyww - Date Code

The 'C' beside the square mark (Pb-Free mark) denotes the use of copper wire.

Example Marking Format: FM25H20-PG

Line 1: FM25H20-PG

Line 2: A 624126

Line 3: CYP1325

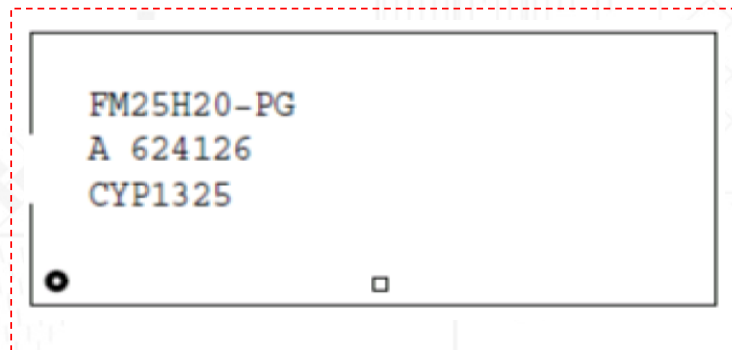

Package:

- PDIP 8L – 300 mils

PDIP 28L

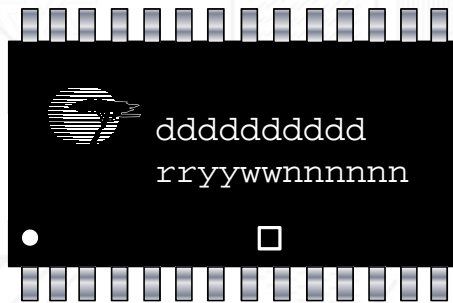

Line 1: Marketing Part Number

Line 2: rrYYWWnnnnnn

where:

rr - BE Part Rev Code (can be 1 or 2 characters)

yyww - Date Code

nnnnnn - Cy assembly lot#

Example Marking Format: FM1608B-PG

Line 1: FM1608B-PG
Line 2: BA1325628365

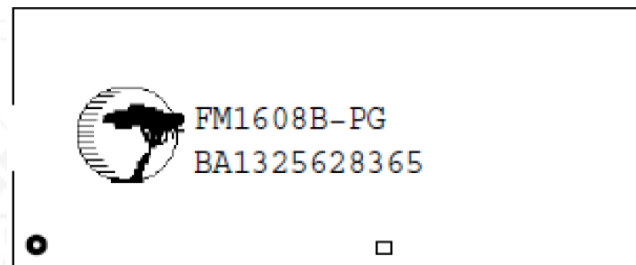

Package:

- PDIP 28L – 600 mils

EIAJ 8L



Row1: Marketing Part Number

Row2: **rrnnnnnn**

where:

rr-BE Part rev Code (can be 1 or 2 characters)

nnnnnn - Cy assembly lot#

Row3: **CYPyyww**

where:

CYP - Cypress

yyww - Date Code

Example Marking Format: FM24V10-G

Line 1: FM24V10-G
Line 2: A 628492
Line 3: CYP1325

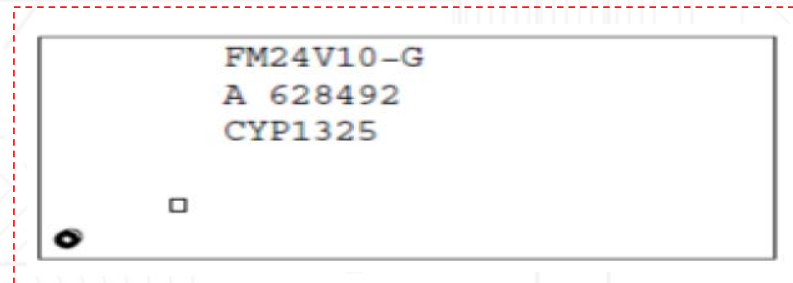

Package:

- EIAJ 8L – 209 mils

SOIC 8L

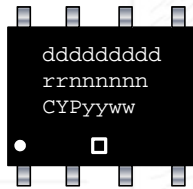

Line 1: Marketing Part Number

Line 2: rrrrrrrrr

where:

rr - BE Part Rev Code (can be 1 or 2 characters)

nnnnnn- Cy assembly lot# n

Line 3: CYPyyww

where:

CYP – Cypress

yyww- Date Code

Example Marking Format: FM24C16B-G

Line 1: FM24C16B-G

Line 2: A 627423

Line 3: CYP1325

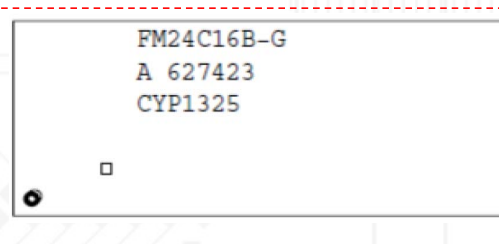

SOIC 14L



Line 1: Marketing Part Number

Line 2: **rrnnnnnn**

where:

rr - BE Part Rev Code (can be 1 or 2 characters)

nnnnnn- Cy assembly lot#

Line 3: **CYP yyww xxx**

where:

CYP – Cypress

yyww – Date Code

xxx – Country of origin

Example Marking Format: FM33256B-G

Line 1: FM33256B-G

Line 2: A 614751

Line 3: CYP 1313 THA

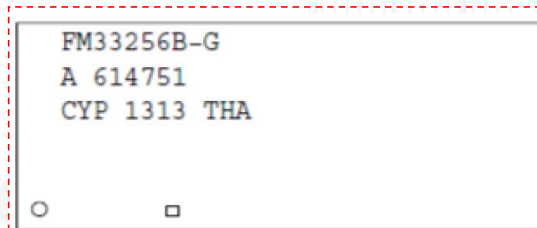

Package:

- SOIC 14 – 150 mils

SOIC 28L



Line 1: Marketing Part Number

Line 2: rryywnnnnnnn

where:

rr - BE Part Rev Code (can be 1 or 2 characters)

yyww - Date Code

nnnnnn - Cy assembly lot#

Example Marking Format: : FM1608B-SG

Line 1: FM1608B-SG
Line 2: B 1325628495



Package:
• SOIC 28 – 300 mils

TSOP 44L



Line 1: Marketing Part Number

Line 2: rrrrrrrrrr

where:

rr-BE Part rev Code (can be 1 or 2 characters)

nnnnnn - Cy assembly lot

Row3: yyww xxx

where:

yyww – Date Code

xxx – Country of origin

Example Marking Format: : FM28V202-TG

Line 1: FM28V202-TG

Line 2: A 631745

Line 3: 1331 TWN

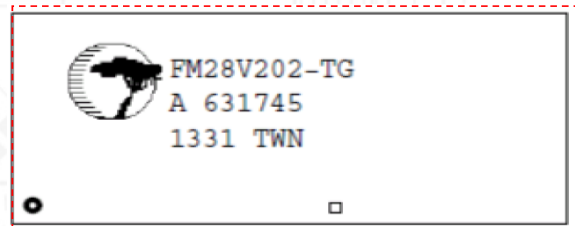

Package:

- TSOP II 44 - 435 mils

TSOP I



Line 1: Marketing Part Number

Line 2: rrrnnnnn

where:

rr – BE Part rev Code (can be 1 or 2 characters)

nnnnn – Cy assembly lot#

Line 3: yyww xxx

where:

yyww – Date Code

xxx – Country of origin

Example Marking Format : FM28V020-TG

Line 1: FM28V020-TG

Line 2: A 615067

Line 3: 1313 TWN

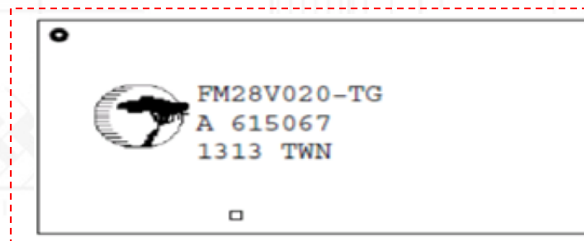

Package:

- TSOP I 28
- TSOP I 32

FLASH PARTS

FBGA



Logo - Spansion Logo

1st line – Part number (ddddddddddddd)

2nd line – Date code, die code (ywwnnnnn x)

3rd line – Country of Origin (coo)

4th line – Copyright (© yy SPANSION)

Example OPN:

S34ML01G100BHV000

S34ML04G100BHI000

S34ML01G100BHI000

S25FL256SAGBHIA10

S25FL256SAGBHIA13



Packages:

VBM063 / LAD080

V2B063 / FAA064

LAA064 / LAA080

VBK048 / LAE064

FAB024 / FAC024

Note:

1. Date code yww: y= last digit of the year, ww= work week, nnnn= location code, X= die code

TSOP



Logo - Spansion Logo

1st line – Part number (dddddddddddddd)

2nd line – Date code, die code (ywwnnnn x)

3rd line – Copyright (© yy SPANSION)

Example OPN:

S29GL064N90TFI04	S29GL128S90TFI010
S29GL032N90TFI04	S29GL256S90TFI020
S34ML01G200TFI000	S29GL256S90TFI010
S29GL256P90TFI010	S29GL128S90TFI020
S34ML02G100TFI000	
S34ML01G100TFI000	

Note:

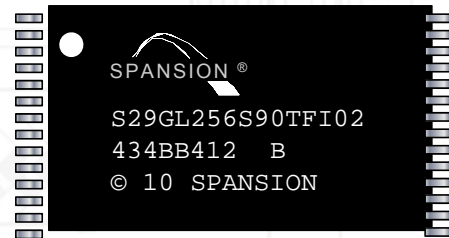

Package:

- TSOP 48
- TSOP 56

1. Date code yww: y= last digit of the year, ww= work week, nnnn= location code, X= die code

SOIC 8L

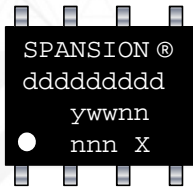

- 1st line – Logo line (SPANSION ®)
- 2nd line – Part number (ddddddddd)
- 3rd line – Date code (ywwnn)
- 4th line – Date code, die code (nnn X)

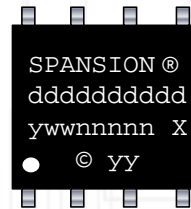

- 1st line – Logo line (SPANSION ®)
- 2nd line – Part number (ddddddddd)
- 3rd line - Date code, Die Code (ywwnnnnn x)
- 4th line - Copyright (© yy)

Example OPN:

S25FL216K0PMFI041
 S25FL116K0XMF1040
 S25FL132K0XMF1041

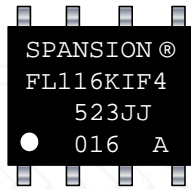

SOIC 8 – 150 mils

Example OPN:

S25FL164K0XMF1011
 S25FL008A0LMFI001
 S25FL016A0LMFI010
 S25FL032P0XMF1010
 S25FL127SABMFI103

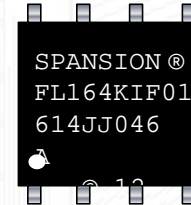

SOC 8 - 208 mils

Note:

1. Date code yww: y= last digit of the year, ww= work week, nnnn= location code, X= die code

SOIC 16L

SO3016 / SL3016



- Logo - Spansion Logo
- 1st line – Part number (d)
- 2nd line – Date code, die code (ywwnnnn X)
- 3rd line – Copyright (© yy SPANSION)

Example OPN:

- S25FL256SAGMFIG01
- S25FL512SAGMFI011
- S25FL256SAGMFI000
- S25FL128SAGMFI003
- S25FL128SAGMFMG00
- S25FL064P0XMFI001



Note:

- 1. Date code yww: y= last digit of the year, ww= work week, nnnnn= location code, X= die code

USON/WSON

Package code:

**WNA008 / UNE008 / WNF008 / WNG008
/ WNH008**

SPANSION®
dddddddddd
ywwnnnnn X
coo
© yy

Logo - SPANSION ®

1st line – Part number
(dddddddddd)

2nd line – Date code, die code
(ywwnnnnn X)

3rd line – Country of Origin
(coo)

4th line – Copyright
(© yy)

Example OPN:

S25FS256SAGNFI001

S25FS256SAGNFI003

S25FS512SAGNFI001

S25FS512SAGNFI003

SPANSION®
FL128SAIF00
622QQ009 A
TAIWAN
© 11

Package:

- WNA008
- UNE008
- WF008
- WNG008
- WNH008

Note:

1. Date code yww: y= last digit of the year, ww= work week, nnnnn= location code

PLCC 32L



PL032

Logo - Spansion Logo

1st line – Part number
(ddddddddd)

2nd line – Part number (extended)
(-ddd)

3rd line – Date code, die code
(ywwnnnnn X)

4th line – Copyright
(© yyyy ZZZ)

Example OPN:

AM29F010B-120JD

AM29F040B-120PD

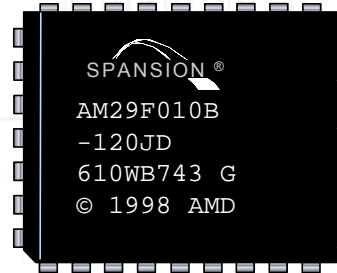

Note:

1. Date code yww: y= last digit of the year, ww= work week, nnnnn= location code, X= die code

PQFP 80L

PQR080

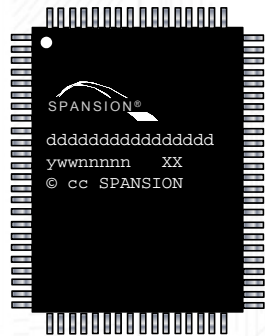

Logo - Spansion Logo

1st line – Part number
(dddddddddddddd)

2nd line – Date code, die code
(ywwnnnnn X)

3rd line – Copyright
(© cc SPANSION)

Example OPN:

S29CD016J0MQFM01

S29CD032J0MQFI000

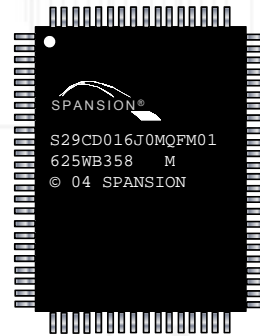

Note:

1. Date code yww: y= last digit of the year, ww= work week, nnnnn= location code, X= die code

IoT PARTS

FBGA/LGA/FCBGA/QFN

```
P1Bddddddd  
dddddddddd  
YwwBRRBFF  
111BNNNNN  
xxxbsqbc
```

Line 1: Pin1dot Marketing Part Number (1st 8 letter)
Line 2: Marketing Part Number remaining
Line 3: Date code, Backend Part Rev, Fab location
Line 4: CYP, assembly lot number
Line 5: COO, Pb Free Square, C for Cu wire

No: "C" Marking is required for FCBGA/RFCFBGA.

Note:

- B : Blank space
- P1 : Pin 1
- D: Marketing Part Number
- YYWW: YY Datecode, WW Work Week
- RR: Backend Part Number
- FF: Fab location
- LLL: CYP

Example Marking Format: CYW20734UA1KFFB3G.

```
● CYW20734  
UA1KFFB3G  
1633 AB 04  
CYP 645842  
TWN □ C
```

Packages: (mm)

- FBGA64 – 7X7
- FBGA81 – 8X8
- FBGA – 9X9, 11X11
- LGA – 6.5X6.5
- FCBGA - 7X9, 8.5X8.5, 10X10, 7X6
- QFN56, QFN60 – 7X7
- QFN68 – 8X8
- QFN52 – 8X7
- QFN76 – 9X9
- QFN88 – 10X10

QFN 40L

P1Bddddddddd
ddddddddd
YwwRRRFF
111BNNNNNN
xxxbbbsqbc

Line 1: Pin1dot Marketing Part Number (1st 7 letter)
Line 2: Marketing Part Number remaining
Line 3: Date code, Backend Part Rev, Fab location
Line 4: CYP, assembly lot number
Line 5: COO, Pb Free Square, C for Cu wire

Note:

- B : Blank space
- P1 : Pin 1
- D: Marketing Part Number
- YYWW: YY Datecode, WW Work Week
- RR: Backend Part Number
- FF: Fab location
- LLL: CYP

Example Marking Format: CYW20736A1KWBG

● CYW2073
6A1KWBG
1633 AB 04
CYP 645842
TWN □ C

Package: (mm)
• QFN40 – 6X6

FBGA

P1Bddddddddd
ddddddddd
YwwBRRB
FFBNNNNNN
xxxbbbsqbc

Line 1: Pin1dot Marketing Part Number (1st 6 letter)
Line 2: Marketing Part Number remaining
Line 3: Date code, Backend Part Rev
Line 4: Fab location, assembly lot number
Line 5: COO, Pb Free Square, C for Cu wire

Note:

- B : Blank space
- P1 : Pin 1
- D: Marketing Part Number
- YYWW: YY Datecode, WW Work Week
- RR: Backend Part Number
- FF: Fab location

Example Marking Format: CYW20733A2KML1G

● CYW207
33A2KML1G
1633 AB
04 645842
TWN □ C

Package: (mm)

- FBGA66 – 5.5X4.5
- FBGA72 – 5.5X5

FBGA/QFN

P1Bddddddddd
ddddddddd
DDBYww
NNNNNN
xxxbbbsqbc

Line 1: Pin1dot Marketing Part Number (1st 5 letter)
Line 2: Marketing Part Number remaining 8 letters
Line 3: Marketing Part Number remaining, date code
Line 4: Assembly lot number
Line 5: COO, Pb Free Square, C for Cu wire

Note:

- B : Blank space
- P1 : Pin 1
- D: Marketing Part Number
- YYWW: YY Date code, WW Work Week
- RR: Backend Part Number
- FF: Fab location

Example Marking Format: CYW2046SB1KUFBG

● CYW20
46SB1KUF
BG 1633
645842
TWN □ C

Packages: (mm)

- FBGA65 – 5x5
- QFN32/QFN40 – 5X5

FBGA 65

```
P1Bddddddddd  
ddddddddd  
DD  
YwwbNNNNNN  
xxxbbbsqbc
```

Line 1: Pin1dot Marketing Part Number (1st 4 letter)
Line 2: Marketing Part Number remaining 7 letters
Line 3: Marketing Part Number remaining
Line 4: Date code Assembly lot number
Line 5: COO, Pb Free Square, C for Cu wire

Note:

- B : Blank space
- P1 : Pin 1
- D: Marketing Part Number
- YYWW: YY Datecode, WW Work Week
- RR: Backend Part Number
- FF: Fab location

Example Marking Format: CYW20713A1KUFBXG

```
● CYW2  
713A1KU  
FBXG  
633 842  
TWN □ C
```

Packages: (mm)
• FBGA65 – 4.5X4

FCBGA 49

P1Bddddddd
dddddddddd
DD
YwwbNNNNNN

Line 1: Pin1dot Marketing Part Number (1st 4 letter)
Line 2: Marketing Part Number remaining 7 letters
Line 3: Marketing Part Number remaining
Line 4: Date code Assembly lot number

Note:

- B : Blank space
- P1 : Pin 1
- D: Marketing Part Number
- YYWW: YY Datecode, WW Work Week
- RR: Backend Part Number
- FF: Fab location

Example Marking Format: CYW20704UA1KFFB1G

● CYW2
713A1KU
FBXG
633 842
TWN □ C

Packages: (mm)
• FCBGA49 – 4.5X4

LGA

P1Bddddddddd
ddddddddd
DD
NNNNNN

Line 1: Pin1dot Marketing Part Number (1st 3 letters)
Line 2: Marketing Part Number remaining 5 letters
Line 3: Marketing Part Number remaining
Line 4: Assembly lot number

Note:

- B : Blank space
- P1 : Pin 1
- D: Marketing Part Number
- YYWW: YY Datecode, WW Work Week
- RR: Backend Part Number
- FF: Fab location

Example Marking Format: CYW20732Y

● CYW
20732
Y 633
842

Packages: (mm)
• LGA27: 3.2X3.5

WLCSP

P1Bddddddddd
dddddd
YwwBRRBFF
NNNNNN
xxxbsqbc

Line 1: Pin1dot Marketing Part Number (1at 8 letters)
Line 2: Marketing Part Number
Line 3: Date code, Backend Part Rev, Fab location
Line 4: CYP assembly lot number
Line 5: COO, Pb Free Square
Line 6: CC-RR for die location

Note:

- B : Blank space
- P1 : Pin 1
- D: Marketing Part Number
- YYWW: YY Datecode, WW Work Week
- RR: Backend Part Number
- FF: Fab location
- LLL: CYP

Example Marking Format: CYW43241XFKWBG

● CYW43241
XFKWBG
1633 AB 04
CYP 645842
TWN □
CC-RR

Packages: (mm)

- WLCSP : 6.51X5.81, 6.57X5.62, 5.73X5.62, 5.88X4.4
4.87X7.67, 4.97X7.5, 4.97X7.7, 4.47X5.67, 4.9X5.84
4.91X5.8, 4.47X5.27, 4.89X5.33, 4.87X5.41, 2.87X4.87
3.01X2.5

WLCSP

P1Bddddddddd
dddddd
YwwBRRB
FFBNNNNN
xxxbsq

Line 1: Pin1dot Marketing Part Number (1st 7 letters)
Line 2: Marketing Part Number
Line 3: Date code, Backend Part Rev
Line 4: Fab location assembly lot number
Line 5: COO, Pb Free Square
Line 6: CC-RR for die location ID

Note:

- B : Blank space
- P1 : Pin 1
- D: Marketing Part Number
- YYWW: YY Datecode, WW Work Week
- RR: Backend Part Number
- FF: Fab location
- LLL: CYP

Example Marking Format: CYW20736A1KWBG

● CYW2073
6A1KWBG
1633 AB
04 645842
TWN □
CCC-RRR

Packages: (mm)

- WLCSP69: 4.53X2.93
- WLCSP/WLCSP36: 2.51X2.77

WLCSP

P1Bddddddd
dddddd
YwwBRRB
FFBNNNNN
xxxbbbsq

Line 1: Pin1dot Marketing Part Number (1st 5 letters)
Line 2: Marketing Part Number
Line 3: Date code, COO
Line 4: Assembly lot number
Line 5: CC-RR for die ID location

Note:

- B : Blank space
- P1 : Pin 1
- D: Marketing Part Number
- YYWW: YY Datecode, WW Work Week
- RR: Backend Part Number
- FF: Fab location
- LLL: CYP

Example Marking Format: CYW20736A1KWBG

● CYW207
36A1KWBG
1633 TWN
645842
CCC-RRR

Packages: (mm)

- WLCSP80: 2.16X2.18

HISTORY PAGE

	Owner	Description of Change
Rev. 7	JARG	<ol style="list-style-type: none"> Updated Slide 38 title from BGA 36 – BGA48 to BGA36, BGA38, BGA60 AND BGA121 Added Example 2 for BGA121 package
Rev. 8	HLR	<ol style="list-style-type: none"> Changed RAMTRON name to FRAM. Added the marking format for uFBGA 48.
Rev. 9	HLR	Corrected the position of leads for FRAM- TSOPI 28L and TSOPI 32L
Rev. 10	HLR	Added the marking format for 60 balls WLCSP and 35 balls WLCSP based on Fig. 127. Added 34 balls WLCSP and 14L DFN based on Fig. 122.
Rev. 11	MRB	Align the marking format for SOJ28-44 (page 11) based from Figure 9 on Final Mark Specification (37-00001) Deleted and replaced the example marking format for TSOP 28 - TSOP 48 (page 20) from 4 liners to 3 liners based from Figure 27 on Final Mark Format Specification (37-00001)
Rev. 12	MRB	Rewrite and pattern the marking explanation of TSOP 28 to TSOP 48 (page 20) from TSOP 32 (page 21)
Rev. 13	MRB	<ol style="list-style-type: none"> Updated Cypress Logo Added available package width size based on spec 37-00001 Deleted Figure 50 on page 67 and Figure 52 on page 63 to align in spec 37-00001 Updated character lines from 4 to 3 line on page 22 based on the example marking format
Rev. 14	MRB	<ol style="list-style-type: none"> Added Legacy Spansion Marking Format Added package size on page 4 and corrected the reference from Figure 45 to Figure 33 Added package size on page 66 and corrected the reference from Figure 45A to Figure 34A

HISTORY PAGE

	Owner	Description of Change
Rev. 15	HLR	Changed the Unit Orientation Format for TSSOP 8.
Rev. 16	MRB	Added IOT Marking format Removed sample word and rewrite/align all ftext Changed to new template
Rev 17	MRB	Corrected the example marking format for LGA 27 (page 88)

End of Memo