

Application & Main Feature

Commercial Grade (Mid Voltage (100 to 630V))

Series

C3216 [EIA 1206]

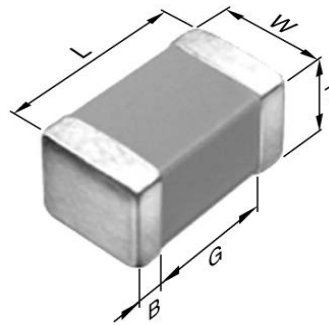

Dimensions

L	3.20mm ±0.20mm
W	1.60mm ±0.20mm
T	1.15mm ±0.15mm
B	0.20mm Min.
G	1.00mm Min.

Temperature Characteristic

CH (-25 to 85 degC 0+/-60ppm/degC)

Rated Voltage

2J(630Vdc)

Capacitance

6.8nF

Capacitance Tolerance

J (±5%)

Q Factor

1000 Min.

Insulation Resistance

10Gohm Min

AEC-Q200

Not Applicable

|Z|, ESR vs. Freq. Characteristics

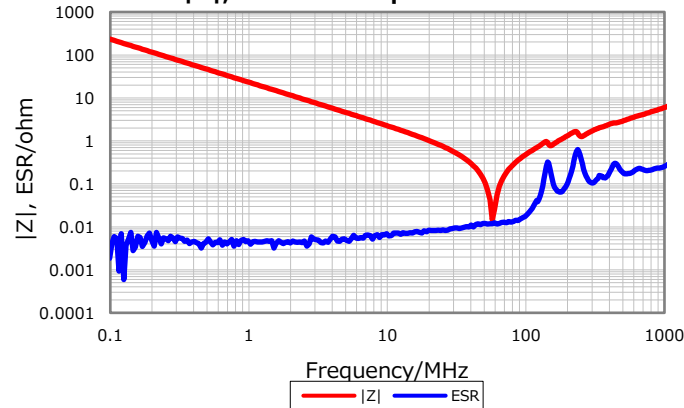

Cap. vs. Freq. Characteristic

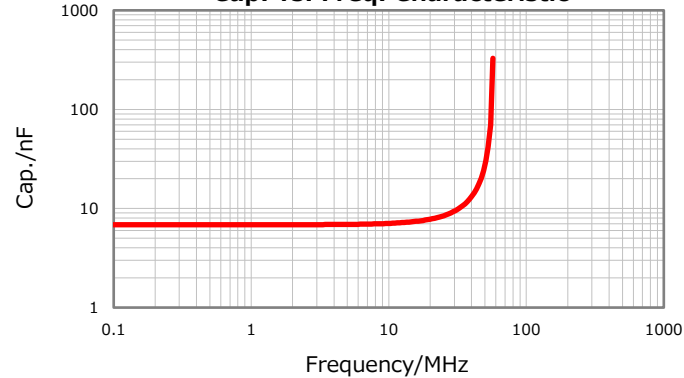

DC Bias Characteristic

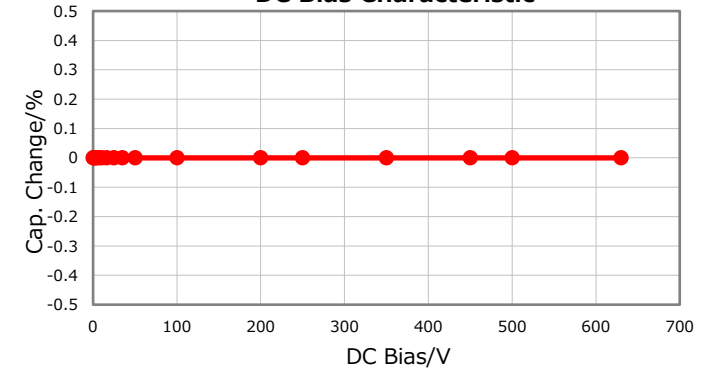

Temperature Characteristics

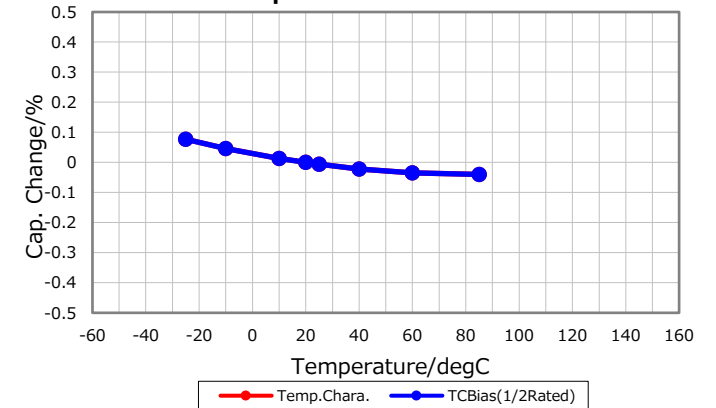

Ripple Temperature Rise Characteristics

