

STK600-ATtiny10

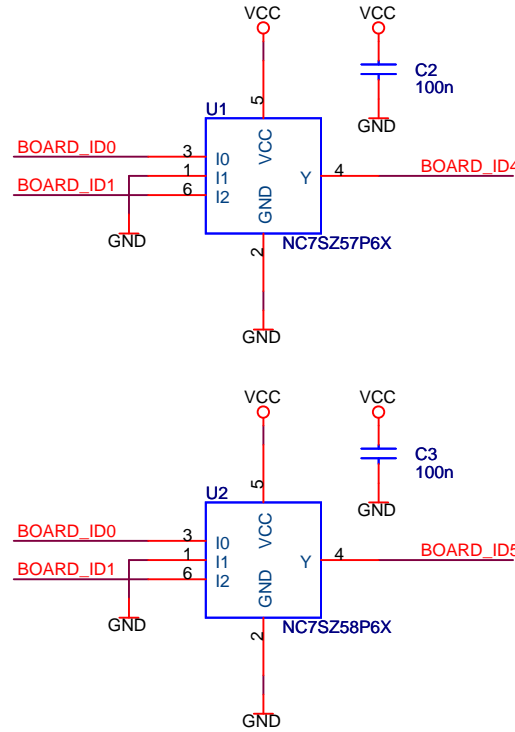

Board id: 0x1E id4: /(A+B) id5: A+B

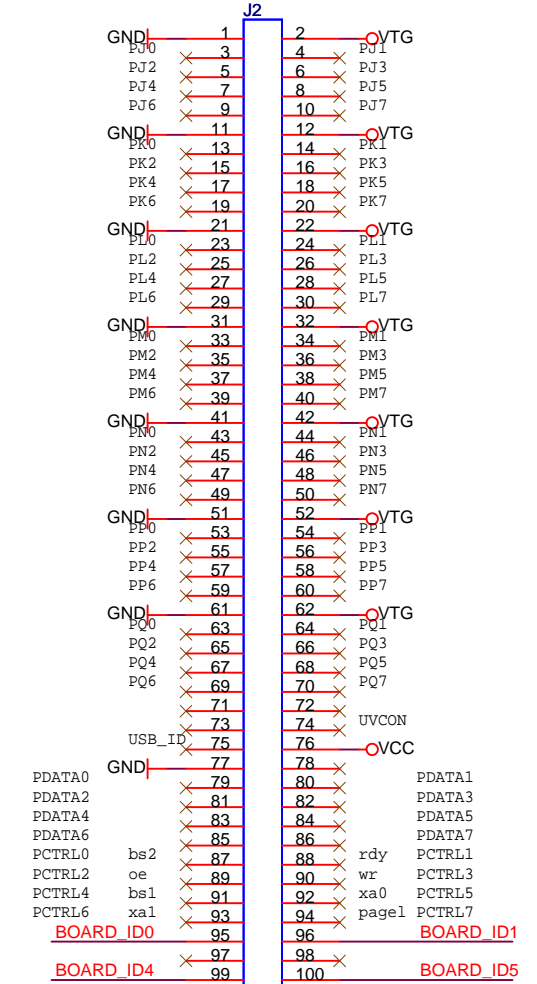
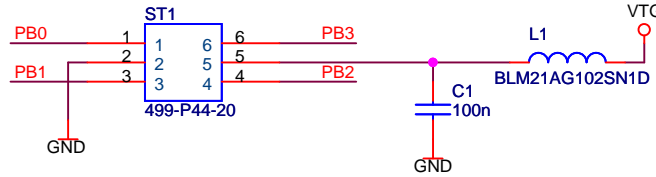
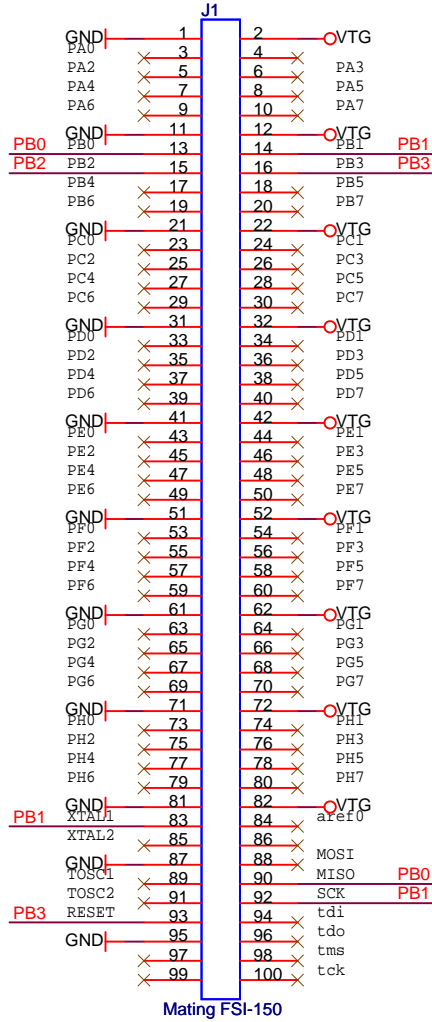
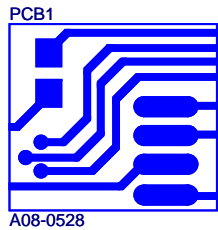

A08-0528

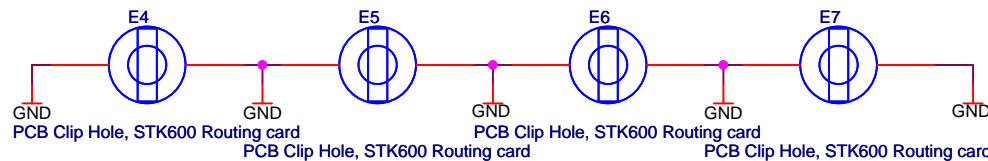
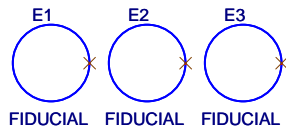

ATMEL Norway AS Vestre Rosten 79 N-7075 TILLER Norway		
Title: STK600-ATtiny10 socket card		
Size: A4	Document Number: <Doc>	Rev: A
Date: Tuesday, July 08, 2008	Sheet: 1 of 1	